

Impeller Trimming of an Industrial Centrifugal Viscous Oil Pump

Wen-Guang Li

Department of Fluid Machinery,
Lanzhou University of Technology, Gansu, China,
E-mail: Liwg47@ymail.com

Received 13 November 2011; Revised 01 December 2011; Accepted 25 December 2011

Abstract: Impeller trimming is a proper way to alter the performance of centrifugal pump with a constant speed so as to meet the demand on the specified flow rate and head in pumping systems. The affinity law accounting for the impeller trimming is the key relation to determine the pump performance with a trimmed impeller. There seems no experimental study dealing with such an affinity law for centrifugal oil pump handling water and viscous oils. In this paper, an experimental investigation into the performance of an industrial centrifugal oil pump of type 65Y60 was explored when the original impeller was trimmed four times. In the experiments water and viscous oils served as the working liquid, respectively. The trimming exponents at both best efficiency and shut-off points were worked out, and compared to those in the existing affinity law for impeller diameter reduction and water. These exponents are very helpful for engineers to determine a trimmed impeller diameter for centrifugal oil pumps handling water and viscous oils with a relative high viscosity. Meanwhile the “rising-efficiency effect” was revealed when a trimmed impeller is delivering highly viscous oils.

Keywords: Centrifugal Oil Pump, Impeller Trimming, Hydraulic Performance, Impeller, Affinity Law, Viscous Oil

Reference: W. G. Li, (2011) ‘Impeller Trimming of an Industrial Centrifugal Viscous Oil Pump’, *Int J Advanced Design and Manufacturing Technology*, Vol. 5/ No. 1, pp. 1-10.

Biographical notes: **W. G. Li** received his PhD in Mechanical Engineering for Petroleum and Gas from University of Petroleum (Beijing), 1996 and MSc in Fluid Machinery and Engineering from Gansu University of Technology, 1989. He is currently Professor at the Department of Fluid Machinery, Lanzhou University of Technology, Gansu, China. His current research interest includes Fluid Dynamics in Impeller Pumps.

1 INTRODUCTION

Impeller trimming is the technique that the impeller diameter of a centrifugal pump is machined to a smaller one. Impeller trimming is an effective way to alter the performance of a centrifugal pump with a constant speed. If the head or flow rate or both provided by a centrifugal pump exceed pumping system requirements, the pump impeller may consider be trimmed. Benefits of impeller trimming are reducing operation and maintenance costs including less liquid energy wasted, relief of noise, vibration and wear in pumping system pipeline, valves and pipeline supports [1]. Thus pump users always prefer to use impeller trimming if the pump impeller is oversized or bypass valves are open in pumping systems.

The essential issue in impeller trimming is how the head and flow rate relate to a trimmed impeller diameter. This problem has been tackled in [2-8] when a centrifugal pump transports water. The aim of those studies is to correlate the head and flow rate at duty point to variable impeller diameter quantitatively so as to determine a correct impeller diameter that meets a target head and a flow rate required by a pumping system. Such a correlation is named affinity law of trimming in [9-15]. Presently, the affinity law can be obtained precisely just by means of the centrifugal pump performance measurement.

The centrifugal oil pump has found extensive application in oilfield, refinery etc to deliver crude oils or petroleum liquids. This kind of pump is often subject to transport a medium with a viscosity more than water. In this case, the existing trimming law for water seems inapplicable. Unfortunately, there is no experimental study to deal with the impeller trimming problem when confronted with a centrifugal oil pump handling highly viscous oils up to now. In this article, this problem will be tackled experimentally.

In this paper, an industrial centrifugal oil pump of type 65Y60 made in China was applied for an experimental model to explore the affinity law of trimming at various kinematical viscosities from $1\text{mm}^2/\text{s}$ to $255\text{mm}^2/\text{s}$. The original impeller, vendor-supplied, with the diameter of 213mm^2 was trimmed four times, its diameter was reduced to 205mm^2 , 195mm^2 , 185mm^2 and 175mm^2 , respectively. The performances of the pumps with the original and trimmed impellers were measured at various viscosities. The results have shown that the affinity law taking into account for impeller diameter reduction is different from that for pumping water, and it depends considerably upon the diameter trimmed and the viscosity of the liquid handled.

2 EXPERIMENTAL MODELS, SETUP AND AFFINITY LAW

The test pump is a single-suction, one-stage, cantilever centrifugal oil pump of type 65Y60 which is widely applied to transport clean crude oils and liquid petroleum products at $-40^\circ\text{C}\sim+350^\circ\text{C}$ in China (Fig. 1(a)). The pump specifications are as follows: flow rate $Q=25\text{m}^3/\text{h}$, head $H=60\text{m}$, rotational speed $n=2950\text{r}/\text{min}$, specific speed $n_s=41.6$, where $n_s=3.65n\sqrt{Q}/H^{0.75}$, n in r/min , Q in m^3/s , H in m , respectively. The impeller style is fully closed, and with 5 blades and a 25° blade discharge angle. The constructions of the pump and impeller have been shown in Fig. 1(a) and (b). The impeller diameter was trimmed four times. The trimming was performed in such a way that the impeller shroud and hub as well as blades were turned down simultaneously (Fig. 1(c)). Here the diameter ratio λ is defined as a ratio of the diameter trimmed of impeller D_{2i} over the original diameter of impeller D_2 , namely $\lambda=D_{2i}/D_2$, where the subscript i stands for trimming index, $i=1, 2, 3, 4$. The trimmed diameters are indicated in Fig. 1(c).

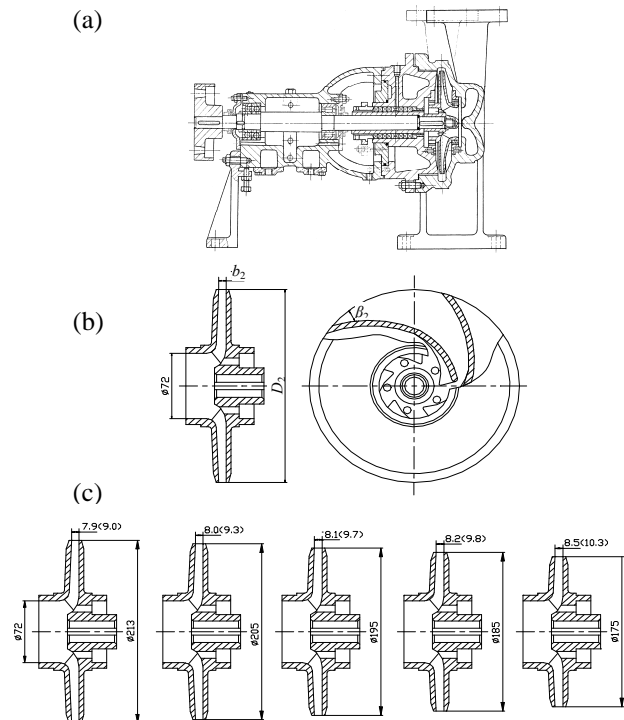

Fig. 1 Construction of the pump and impeller, (a) pump cross-section view, (b) impeller style, (c) impeller trimming fashion, the numerical values outside () are the blade outlet width b_2 designed, the figures inside () are b_2 measured on the real impellers

Fig. 2 shows the sketch of the test rig that was applied to test the performance of centrifugal oil pump while handling water and viscous oils. The liquid flows from the tank and into pump through a globe valve and the suction pipe, finally returns to the tank through the discharge pipe. On the tank four side walls, four 2 kW and two 1 kW electrical heaters were installed. When the oils are used as working fluid in experiment, those heaters will be switched on to raise the oil temperature so as to reduce the viscosity of oil. There is a baffle in the tank to stabilize the flow and to ensure the liquid streams into suction pipe without turbulence. A thermal coupling was fitted on the suction pipe but immediately to the tank to monitor oil temperature.

A torque detector of type PI100 was applied to measure and display the torque, rotational speed and shaft-power of pump. The accuracies of the detector are 0.1%, 0.3% and 0.5% for rotational speed, torque and shaft-power.

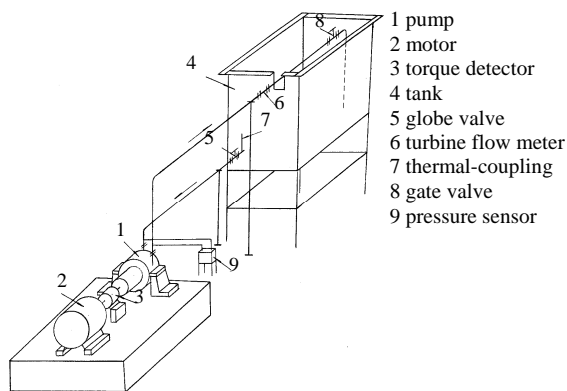

Fig. 2 Sketch of test rig

A turbine flow meter of type LW-50 and a universal digital frequency counter of type PP11 α were utilized to measure the pump flow rate. The accuracies of both the flow meter and counter are 0.5%. The pressure differential across the pump suction and discharge nozzles was acquired by means of a digital voltage meter of type PZ-75 that was connected to a pressure sensor of type 1151DP. The measuring range and accuracy of the sensor are 0-1MPa and 0.25%, those of the voltage meter are 0.4-2V and 0.5%. Before test the pressure sensor was calibrated by using a piston pressure meter of type YS-60 whose accuracy is 0.05%.

The pump is driven through a torque detector of type JC1A by an AC motor whose rated power and speed are 22 kW and 2950r/min, respectively.

The total uncertainties of flow rate, head, shaft-power and efficiency are 0.707%, 0.205%, 0.515% and 0.908%, respectively.

The density of sample oil was measured by glass tube density meter. The accuracy and measuring range of the meter are 1% and 800-900kg/m³. The dynamic viscosity of sample oil was determined by using of a rotational viscometer of type ZND-6 with the accuracy of 0.1% and measuring range of 1-500kg/(m.s). During density and dynamic viscosity measurements, a mercury-in-glass thermometer (accuracy: 0.1%, range: 0-100°C) was used to monitor the sample oil temperature.

The working liquids are water and machine oil of No. 100. The oil density and dynamic viscosity are affected largely by temperature. Some sample oil was heated, and then the density and dynamic viscosity of the oil were measured by using the glass tube density meter and the rotational viscometer, respectively, when the oil was left in the air to cool gradually. Finally, the kinematic viscosity of oil was calculated based on the density and the dynamic viscosity at different temperatures.

The experiment results confirm that water and the machine oil are Newtonian fluids. The density and kinematic viscosity of water are 1000kg/m³, 1mm²/s at 20°C, respectively. Based on the experimental data, the following formulas can be proposed as to estimate the density and kinematic viscosity of the machine oil.

$$\begin{cases} \rho = 906.653 - 0.526715 T \\ \nu = 2 \times 10^{-6} e^{5554.3/(T+273.15)} \end{cases} \quad (1)$$

where ρ , ν and T stand for the density, kinematical viscosity and temperature in °C of the oil, respectively. In the experiments, the values of the kinematical viscosity of working liquids are chosen to be 1 (water), 29, 45, 75, 98, 134, 188 and 255mm²/s (oil).

The performance tests were conducted from a low temperature to a high one for convenience of viscosity adjustment. The experiments were usually conducted in winter (December-January), the mean temperature indoors is 15°C, the mean outdoor temperature is 7.3°C to achieve the highest viscosity. The experiments were started from the lowest temperature of 26°C and were ended up with the highest one of 67°C. Because of the large friction between the pipeline and the pipe in temperature higher than 35°C, the oil temperature rise around 2.3°C for each experiment, causing a maximum reduction of 27.8mm²/s in viscosity. When the oil temperature is higher than 35°C, the oil temperature

rise is very small, and the change caused in the viscosity is negligible.

The affinity law can be used to estimate the hydraulic performance that is not shown on the performance chart for a centrifugal pump with change in speed or impeller diameter. The affinity law accounting for change in impeller diameter is considered only here. Fig. 3 illustrates the velocity triangles in similarity at the impeller outlet when a centrifugal pump is operated at the best efficiency point (BEP) before and after the pump impeller is trimmed. For a low specific speed centrifugal pump like that in this paper, it is most likely that the impeller outlet discharge area and the blade exit angle remain unchanged after trimming, as shown in [9-14], the affinity law for impeller diameter reduction should be written as the following set of equations

$$\begin{cases} Q_i/Q = \lambda^{n_1} \\ H_i/H = \lambda^{n_2} \\ P_i/P = \lambda^{n_3} \\ \eta_i/\eta = \lambda^{n_4} \end{cases} \quad (2)$$

where $n_1=1$, $n_2=2$, $n_3=3$ and $n_4=0$, and n_1 , n_2 , n_3 and n_4 are defined as the trimming exponents in this paper, which correspond to flow rate, head, power and efficiency. Q , H , P and η are the flow rate, head, power and efficiency at BEP for the original impeller, Q_i , H_i , P_i and η_i for a trimmed impeller.

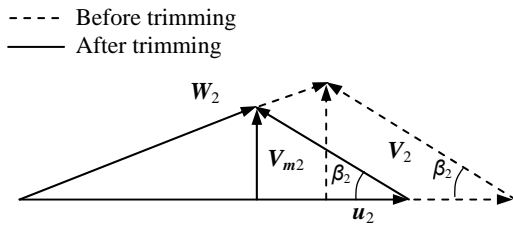

Fig. 3 Velocity triangles in similarity before and after impeller trimmed at impeller outlet, W_2 -relative velocity, V_2 -absolute velocity, u_2 -impeller tip speed, V_{m2} -meridian velocity

At shut-off operation point, both flow rate and efficiency are zero, and only head and power are available only. Hence the affinity law will yield the following equation.

$$\begin{cases} H_i/H = \lambda^{n_{20}} \\ P_i/P = \lambda^{n_{30}} \end{cases} \quad (3)$$

where n_{20} , n_{30} are the trimming exponents at shut-off point respectively, and can be determined by using the experimental data of the performance.

The affinity law includes four exponents, such as n_1 , n_2 , n_3 and n_4 at BEP, and two exponents, n_{20} , n_{30} at shut-off point. If they are defined for a centrifugal oil pump, the law will be available. The theoretical values $n_1=1$, $n_2=2$, $n_3=3$ and $n_4=0$ are approximate to an actual situation because after an impeller is trimmed, some changes occur in the geometrical parameters of the blade outlet. Therefore, those exponents need to be determined by using the experimental data of the performance of a centrifugal oil pump.

After the natural logs being taken, Eq. (2) is rearranged, eventually the four exponents can be calculated by using the following set of equations

$$\begin{cases} n_1 = \ln(Q_i/Q)/\ln \lambda \\ n_2 = \ln(H_i/H)/\ln \lambda \\ n_3 = \ln(P_i/P)/\ln \lambda \\ n_4 = \ln(\eta_i/\eta)/\ln \lambda \end{cases} \quad (4)$$

nonetheless, these exponents are the function of the specific speed n_s , the viscosity of liquid delivered ν and diameter ratio λ . The specific speed of our centrifugal oil pump can be regarded as a constant, consequently $n_i = n_i(\nu, \lambda)$ ($i=1, 2, 3, 4$).

Likewise, at the shut-off condition, the trimming exponents of head and shaft-power can be calculated by the following equations

$$\begin{cases} n_{20} = \ln(H_{0i}/H_0)/\ln \lambda \\ n_{30} = \ln(P_{0i}/P_0)/\ln \lambda \end{cases} \quad (5)$$

where H_0 and P_0 are the head and shaft-power at the shut-off condition for the original impeller, H_{0i} and P_{0i} are the head and shaft-power at the same condition for a trimmed impeller.

3 RESULTS

Fig. 4 illustrates the hydraulic performance curves of the pump with five impeller diameters, such as 213, 205, 195, 185 and 175mm when pumping water at the rotating speed of 2950 r/min. It is obvious that the head, shaft-power and efficiency curves are decreased continuously with reducing diameter. Such variation patterns are similar to those in pervious investigations presented in [2, 3, 6, 8].

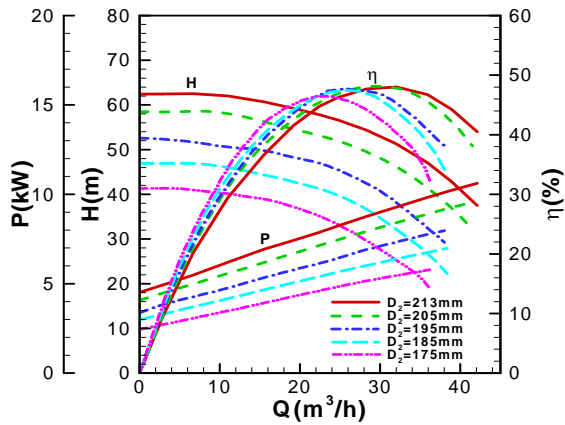

Fig. 4 Pump performance of pumping water at various impeller diameters

The trimming exponents n_1 to n_4 estimated by means of Eq. (4) based on the experimental data at BEP are shown in Fig. 5 in terms of the impeller diameter ratio λ . Likewise, the trimming exponents n_{20} and n_{30} predicted with Eq. (5) at the shut-off point are indicated in Fig. 6 as well. Those exponents slightly depend on the impeller diameter ratio. Such an effect has been observed in [6].

If the effect of impeller diameter ratio on the exponents is neglected, the following affinity laws accounting for impeller diameter reduction at BEP and shut-off condition can be arrived

$$\begin{cases} Q_i/Q = \lambda^{1.445(1)} \\ H_i/H = \lambda^{2.090(2)} \\ P_i/P = \lambda^{3.346(3)} \\ \eta_i/\eta = \lambda^{0.153(0)} \end{cases} \quad (6)$$

and

$$\begin{cases} H_{0i}/H_0 = \lambda^{1.957(2)} \\ P_{0i}/P_0 = \lambda^{3.015(3)} \end{cases} \quad (7)$$

where the figures in () are the theoretical exponents in the existing affinity law Eq. (2).

Note that n_2 receive values close to the theoretical value 2. The flow rate, shaft-power and efficiency exponents n_1 , n_3 and n_4 seem to disagree with the theoretical affinity law. At the shut-off point, however, two experimental exponents also approach the theoretical values 2 and 3.

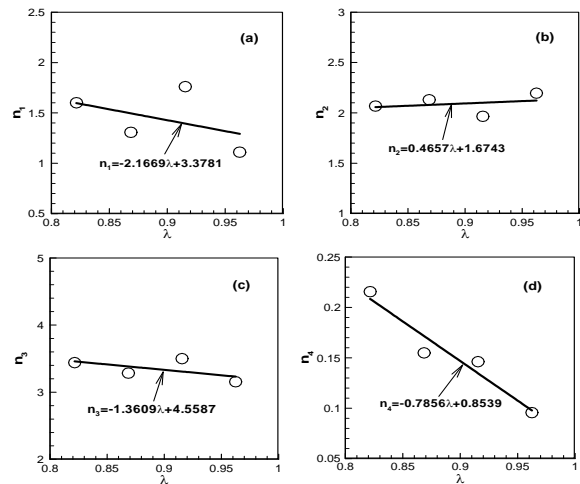

Fig. 5 Trimming exponents in terms of impeller ratio at BEP when handling water, (a) n_1 , (b) n_2 , (c) n_3 , (d) n_4 , symbols represent experiments, solid lines are for curve fitting, and the solid fitted lines are depicted with their formulas

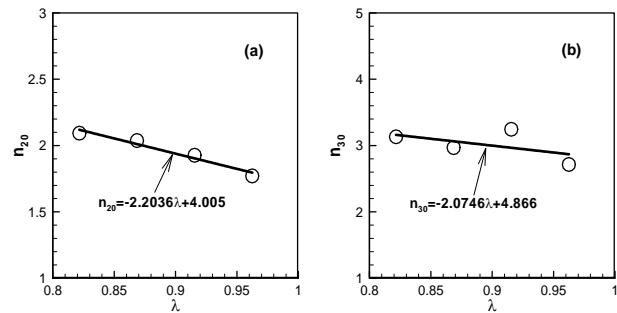

Fig. 6 Trimming exponents in terms of impeller ratio at shut-off point when handling water, (a) n_{20} , (b) n_{30} , the mentioned equations represent fitted solid lines

Fig. 7 presents the pump performance for five impeller diameters, namely 213, 205, 195, 185 and 175mm when the pump delivers the liquids with the viscosities of 1, 29, 45, 75, 98, 134, 188 and 255mm²/s at a constant speed of 2950r/min. It can be seen that the head and shaft-power curves move down and the flow rate of BEP is lowered with reducing impeller diameters at various viscosities, so does the efficiency curve at the viscosity of 1mm²/s. However, when the viscosity is beyond 29mm²/s, the efficiency curve shows a best efficiency with the impeller of 205mm² diameter compared to those with the other ones. Here, such an effect is named “rising-efficiency effect” that apparently does not appear to have ever been reported in the literature until now. The peak efficiency against viscosity at five impeller diameters is plotted in Fig. 8 and this effect is showed clearly.

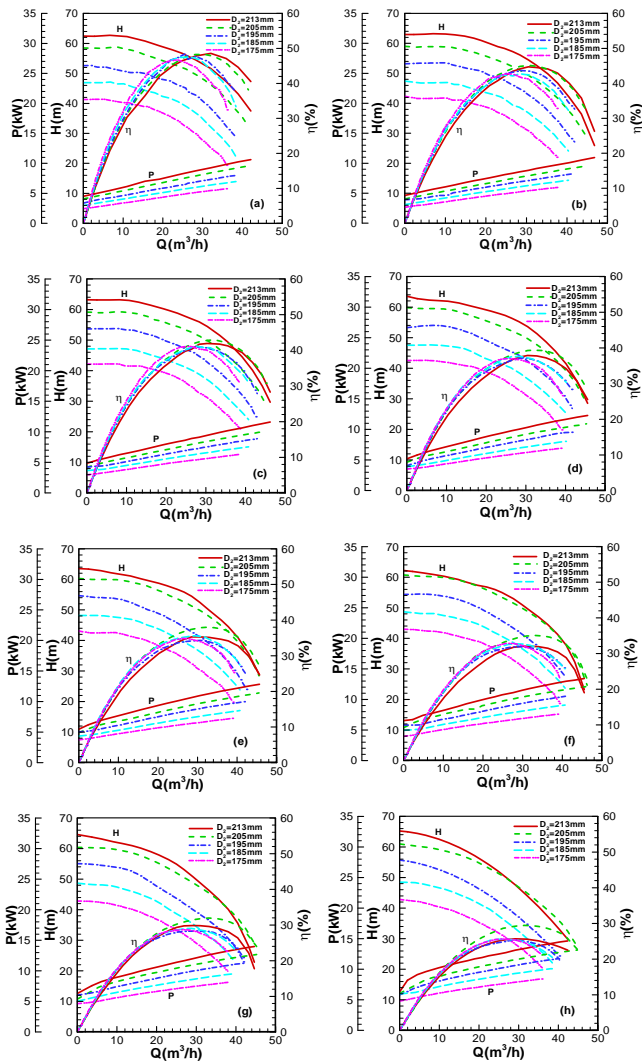

Fig. 7 Pump performance with five impeller diameters at various viscosities, (a)1mm²/s, (b)29mm²/s, (c)45mm²/s, (d)75mm²/s, (e)98mm²/s, (f)134mm²/s, (g)188mm²/s, (h)255mm²/s

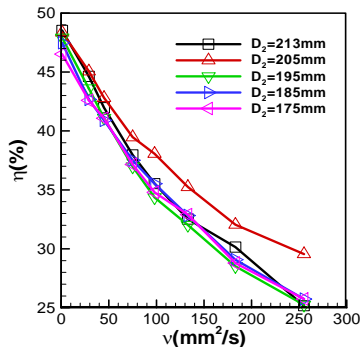

Fig. 8 Pump peak efficiency in terms of viscosity for five impeller diameters

According to Eq. (4) and (5), the trimming exponents n_1 through n_4 at BEP as well as n_{20} and n_{30} at shut-off condition can also be obtained for viscous oil. In this case, the Q , H , P and η in Eq. (4), or H_0 and P_0 in Eq. (5) are specified as the parameters at BEP or at shut-off condition when the impeller with the original diameter transporting water ($1\text{mm}^2/\text{s}$). The exponents established in this way have involved a strong effect of viscosity and have been revealed in Fig. 9 in terms of impeller Reynolds number $Re_2 (= \omega D_{2i}^2 / 4\nu)$.

The experimental exponents not only depend upon λ but also Re_2 . When $Re_2 > 10^5$ ($\nu < 30\text{mm}^2/\text{s}$), the exponents show less variations with Re_2 . Moreover the effect of Re_2 on the exponents seems to become less significant with decreasing λ .

When $Re_2 > 10^5$ ($\nu < 30\text{mm}^2/\text{s}$), the trimming exponent of flow rate n_1 is limited in 1~2. However, if $Re_2 < 10^5$ ($\nu > 30\text{mm}^2/\text{s}$), then $0 < n_1 < 1$, except the case of $D_2 = 205\text{mm}^2$, indicating the increasing viscosity moves the BEP to somewhere at a lower flow rate. In the case of $D_2 = 205\text{mm}^2$, $n_1 < 0$, showing the increasing viscosity allows the BEP to be moved to a higher flow rate and leading to an improved pump performance (see Fig. 7).

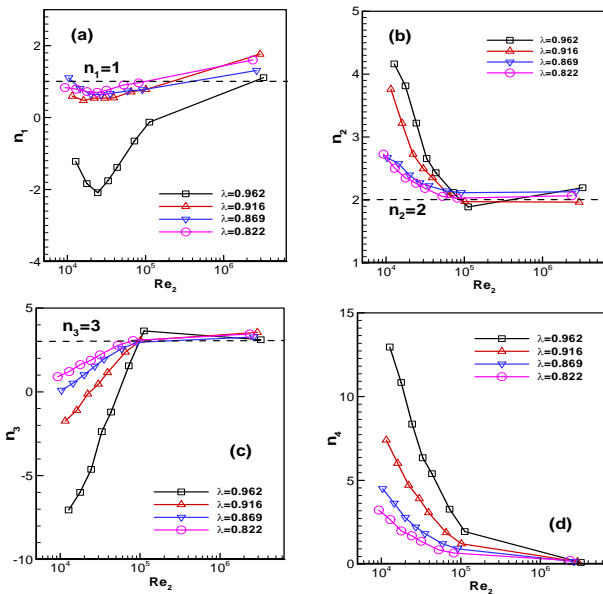

Fig. 9 Trimming exponents in terms of impeller Reynolds number at BEP when the reference performance is for water with the original diameter, (a) n_1 , (b) n_2 , (c) n_3 , (d) n_4

In most, the trimming exponent of head $n_2 > 2$, also rises with decreasing Re_2 , but it declines along with

reducing λ . Once again, the effect of Re_2 on n_2 gets less substantial with decreasing λ .

The trimming exponent of shaft-power n_3 is considerably declined from a theoretical value of 3 with decreasing Re_2 . The larger the λ , the more n_3 undergoes reduction.

The trimming exponent of efficiency n_4 rises rapidly with decreasing Re_2 , the smaller the λ , the more significant the reduction in n_4 .

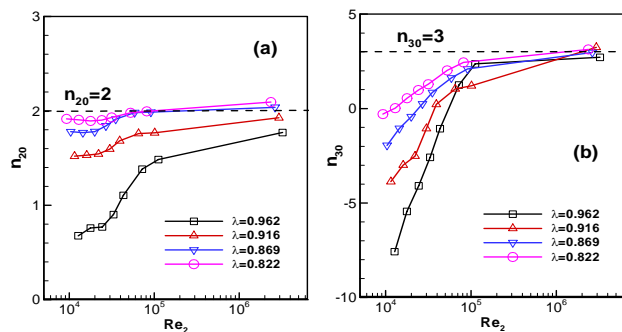

Fig. 10 Trimming exponents in terms of impeller Reynolds number at shut-off condition when the reference performance is for water with the original diameter, (a) n_{20} , (b) n_{30}

The trimming exponents of head and shaft-power n_{20} , n_{30} are plotted against Re_2 in Fig. 10. The relation between n_{20} and Re_2 seems reverse to that between n_2 and Re_2 , and $n_{20} < n_2$. The relation between n_{30} and Re_2 resembles to that between n_3 and Re_2 , but n_{30} gets a more rapidly declining slope.

These six experimental trimming exponents share a common variation tendency against Re_2 , namely the effect of Re_2 is relieved with reducing impeller diameter, causing the exponents approach the corresponding theoretical values.

4 DISCUSSION

It is clear the trimming exponents of flow rate, head, shaft-power and efficiency are dependent to impeller diameter for water as shown in Fig. 5. This is believed that geometrical similarity at impeller outlet is destroyed in some extent among the impellers trimmed and the original one. Fig. 11 demonstrates the blade exit angle β_2 and outlet width b_2 measured in terms of impeller diameter. It is obvious that once the experimental impeller is trimmed, a significant change in β_2 and b_2 will occur, the figure shows the

maximum increases in β_2 and b_2 have reached to 26% and 15.6%.]

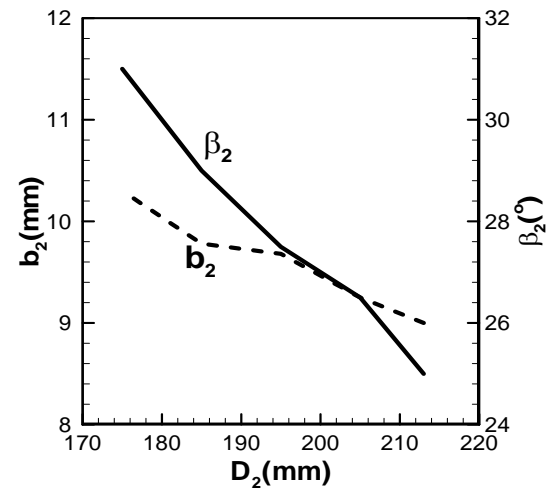

Fig. 11 Blade exit angle β_2 and blade outlet width b_2 when the impeller is trimmed

For water, the trimming exponents in this paper have been compared those in literature and shown in Table 1. In the table, the first two rows represent the affinity law in theory accounting for impeller trimming based on the assumption of geometrical similarity at impeller outlet when trimmings are carried out. The rest is for various types of centrifugal pump. Those exponents will be helpful to guide impeller trimming.

Table 1 Comparison of trimming exponents in literature and this paper for water

Ref.	n_1, n_4	n_2
[7, 9, 10]	2, 0	2
[11-13]	1, 0	2
	1.0885+	1.53448+
[11]	$0.293315(\frac{n_s}{100}), 0$	$0.8438(\frac{n_s}{100})$
[2]	1.57, 0	2.6
[3]	1.87, 0	1.54
[3]	1.8, 0	2.3
[6]	1.7, 0	2.63
[6]	1.6, 0	2.3
[6]	$Q_i/Q=2.1 \lambda - 1$ $\eta_i/\eta=0.45 \lambda + 0.55$	2
This paper	1.445, 0.153	2.090

In the previous section, the experimental exponents are identified in such a way that the performance parameters with the original impeller diameter for water are assigned to Q , H , P and η in Eq. (4), or H_0 and P_0 in Eq. (5). This is just the case that the performance of a centrifugal oil pump with the original impeller diameter handling for water is known. If the performance of the pump with the original impeller diameter for viscous oil has been available already, then the Q , H , P and η in Eq. (4), or H_0 and P_0 in Eq. (5) can be the performance parameters at this certain viscosity with the original impeller diameter. The experimental trimming exponents extracted in this way are indicated in Fig. 12 and 13.

It is clear this group of the experimental exponents is quite different from that in Fig. 9 and 10 where the reference performance is for pumping water with the original diameter. From Fig. 12 and 13, it can be observed that the trimming exponents are related to both impeller diameter ratio and liquid viscosity, and rise with increasing Reynolds number Re_2 .

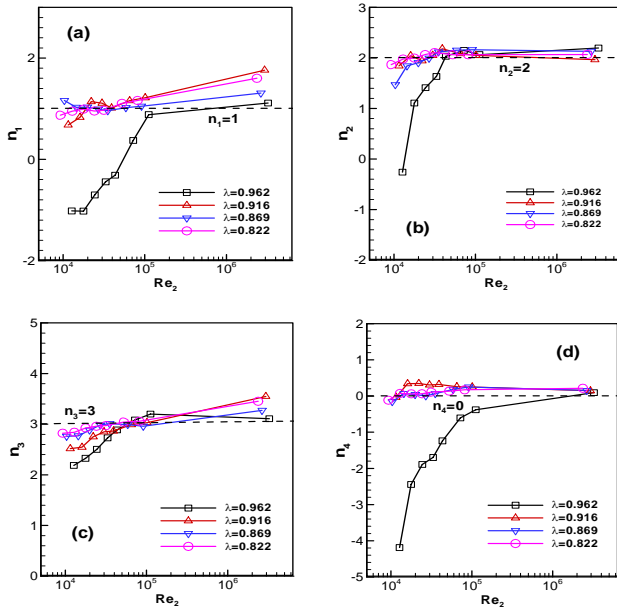

Fig. 12 Trimming exponents in terms of impeller Reynolds number at BEP when the reference performance is for individual viscous oil with the original diameter, (a) n_1 , (b) n_2 , (c) n_3 , (d) n_4

Except $\lambda=0.962$, the exponents seem to be close to the theoretical exponents. It suggests that if the viscous oil performance of a centrifugal oil pump at a certain

viscosity is known, then the existing theoretical or experimental trimming exponents of water or those in Fig. 12 and 13 can be used to estimate the viscous oil performance of the pump with a trimmed impeller at that viscosity.

Except $\lambda=0.962$, the exponents seem to be close the theoretical exponents. It suggests that if the viscous oil performance of a centrifugal oil pump at a certain viscosity is known, then the existing theoretical or experimental trimming exponents of water or those in Fig. 12 and 13 can be used to estimate the viscous oil performance of the pump with a trimmed impeller at that viscosity.

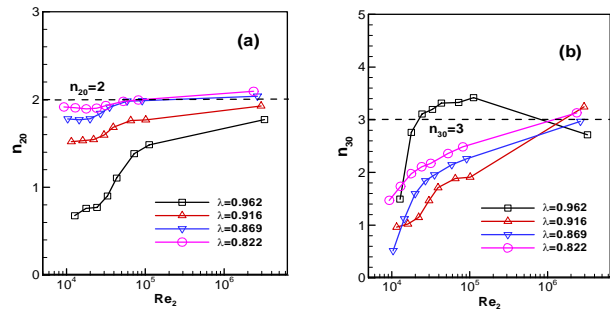

Fig. 13 Trimming exponents in terms of impeller Reynolds number at shut-off condition when the reference performance is for individual viscous oil with the original diameter, (a) n_{20} , (b) n_{30}

For viscous oils, a curve fitting procedure was conducted for the trimming exponents at BEP and shut-off condition as shown in Figs. 9 and 10 by using a 4-order polynomial $n_i = a_4v^4 + a_3v^3 + a_2v^2 + a_1v + a_0$, $i=1, 2, 3, 4$, where the coefficients a_4 , a_3 , a_2 , a_1 and a_0 have been listed in Table 2 and 3. Since the experimental exponents are related to impeller diameter ratio λ as well, they differ from one ratio to another. Table 2 and 3 are ready to be applied in practice for impeller trimming of centrifugal oil pump. Note that correlating the trimming exponents to viscosity is easy for use compared to Reynolds number Re_2 .

In order to uncover the mechanism behind the “rising-efficiency effect” in the pervious section, the hydraulic, volumetric and mechanical efficiencies, i.e. η_h , η_V , η_m and slip factor σ (slip velocity at impeller outlet over the tip speed of impeller) have been extracted at the impeller diameters of 213, 205 and 195mm by using the last updated version of the method shown in [16].

Table 2 Experimental trimming exponents for viscous oils at BEP

Exponent	λ	a_4	a_3	a_2	a_1	a_0
n_1	0.962	0	0	1.31433e-4	-4.26235e-2	1.18625
	0.916	0	-3.24197e-7	1.6494e-4	-2.52641e-2	1.63592
	0.869	0	0	3.57847e-5	-9.25939e-3	1.17171
	0.822	0	0	3.23682e-5	-1.01759e-2	1.41239
n_2	0.962	1.68662e-9	-1.36672e-6	3.3416e-4	-1.64379e-3	2.15966
	0.916	3.16377e-10	-2.50662e-7	7.1456e-5	3.69193E-5	1.93073
	0.869	-9.22474e-10	3.35331e-7	-2.03787e-5	8.63723e-4	2.11907
	0.822	1.4025e-9	-7.31191e-7	1.23817e-4	-4.6981e-3	2.07101
n_3	0.962	0	1.03993e-6	-2.47479e-4	-4.67675e-2	3.87176
	0.916	0	1.37402e7	1.59058e-5	-3.44853e-2	3.76056
	0.869	0	1.249e-7	-1.02496e-5	-1.82887e-2	3.36747
	0.822	0	-1.78196e-8	4.27211e-5	-1.9984e-2	3.52758
n_4	0.962	0	0	-1.03297e-4	7.75535e-2	-5.9198e-2
	0.916	0	0	-5.74728e-5	4.32349e-2	8.45832e-2
	0.869	0	0	-2.4899e-5	2.32217e-2	1.95372e-1
	0.822	0	0	-1.79237e-5	1.65058e-2	1.91819e-1

Table 3 Experimental trimming exponents for viscous oils at shut-off condition

Exponent	λ	a_4	a_3	a_2	a_1	a_0
n_{20}	0.962	0	0	2.65144e-5	-1.10331e-2	1.8083
	0.916	0	0	9.89978e-6	-4.10232e-3	1.92705
	0.869	0	0	6.33717e-6	-2.7801e-3	2.0657
	0.822	0	0	6.95751e-6	-2.36945e-3	2.079
n_{30}	0.962	0	3.72046e-7	-5.39825e-5	-5.31259e-2	3.54611
	0.916	0	0	1.3195e-4	-5.91226e-2	3.43638
	0.869	0	0	5.10622e-5	-3.2559e-2	3.13449
	0.822	0	0	5.4088e-5	-2.78109e-2	3.26443

The useful information about them is presented in Fig. 14. It is obvious that the pump is subject to improved hydraulic and mechanical efficiencies and a degraded slip factor when the effect is going on. Also, it implies that there exists an optimal gap between the impeller outlet and the volute tongue for viscous oils, and it differs from the optimal one for water. The improvement in these three variables is likely relevant to changes in flow patterns inside the impeller and two chambers between the impeller and the pump casing when the impeller trimmed is pumping the viscous oil. Such an issue will be clarified in the forthcoming studies based on CFD simulations or a flow field survey.

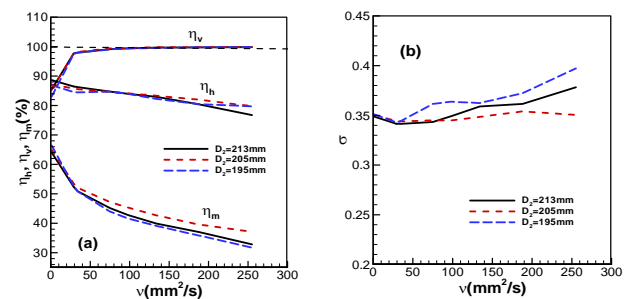

Fig. 14 Pump hydraulic, volumetric and mechanical efficiencies (a) and slip factor (b) in terms of viscosity with impeller diameters of 213, 205 and 195mm

5 CONCLUSION

An experimental investigation into the performance of an industrial centrifugal oil pump of type 65Y60 has been carried out at various viscosities of liquid when the pump original impeller is trimmed. The trimming exponents, at both best efficiency and shut-off points have been figured out. The experimental exponents have been compared to the existing results. The experimental trimming exponents depend on impeller diameter trimmed and liquid viscosity. The presented trimming exponents are useful for estimating the water or viscous oil performance of centrifugal oil pump when its impeller is subject to be trimmed. The “rising-efficiency effect” has been identified and it is most likely related to the improvement in hydraulic, mechanical efficiencies and a less slip factor when the turned down impeller is handling highly viscous oils. A further confirmation needs to be provided by means of CFD flow simulations or experimental observations.

ACKNOWLEDGMENTS

This work was supported by the key research and development program for excellent research groups and the university R&D fund (Grant No. 62102), Lanzhou University of Technology, Gansu, China

REFERENCES

- [1] Asdal, R., Block, H. P. E., Casada D., “Improving Pumping System Performance-A Sourcebook for Industry”, Motor Challenge, Washington DC, 1999.
- [2] Smoilovskaya, L .A., “Impeller of Low Speed Centrifugal Pumps for Abrasive Slurries”, Chemical and Petroleum Engineering, No. 4, 1968, pp. 9-12.
- [3] Lin, D. H., Hu, Z. M. and Xue, D. S., “Experiments on Impeller Trimming of a Multi-Stage Centrifugal Diffuser Pump”, Pump Technology, No. 3, 1985, pp. 26-29.
- [4] Tsang, L. M., “A Theoretical Account of Impeller Trimming of the Centrifugal Pump”, Proceedings of the Institution of Mechanical Engineer, Part C, Journal of Mechanical Engineering Science, Vol. 206, No. 3, 1992, pp. 213-214.
- [5] Shields, S., “When Trimming a Centrifugal Pump Impeller can Save Energy and Increase Flow Rate”, World Pumps, No. 398, 1999, pp. 37-40.
- [6] Ukhin, B. V., “Effect of Variation in the Diameter of a Centrifugal Dredge Impeller on its Characteristics”, Power Technology and Engineering, Vol. 41, No.1, 2007, pp. 8-13.
- [7] Singh, G. and Mitchell, J. W., “Energy Savings from Pump Impeller Trimming”, ASHRAE Journal, Vol. 40, No. 4, 2009, pp. 34-44.
- [8] Savar, M., Kozmar, H. and Sutlovic, I., “Improving Centrifugal Pump Efficiency by Impeller Trimming”, Desalination, Vol. 249, No. 2, 2009, pp. 654-659.
- [9] Stepanoff, A. J., “Centrifugal and Axial Flow Pumps”, John Wiley & Sons, New York, 1947.
- [10] Lazarkiewicz, S. and Trokolanski, A. T., “Impeller Pumps”, Pergamon Press, Oxford, 1965.
- [11] Guan, X. F., “Theory and Design of Impeller Pumps”, Machinery Industrial Press, Beijing, 1986.
- [12] Karassik, I. J. and NcGuire, T., “Centrifugal Pumps”, Chapman & Hall, New York, 1998.
- [13] Karassik, I. J., Messina, J., Cooper, P. and Heald, C., “Pump Handbook”, 4th Edition, McGraw-Hill, New York, 2001.
- [14] Gulich, J. F., “Centrifugal Pumps”, Springer, Berlin, Germany, 2010.
- [15] Nelik, L., Centrifugal and Rotary Pump, CRC Press, Boca Raton, 1999.
- [16] Li, W. G., “A Method for Analyzing the Performance of Centrifugal Oil Pumps”, ASME Journal of Fluids Engineering, Vol. 126, No. 3, 2004, pp. 482-485.