

Proportional-derivative Fuzzy Control of Conjugated Polymer Actuators

A. A. Amiri Moghadam*

Department of Mechanical Engineering,
Gonabad Branch, Islamic Azad University, Gonabad, Iran
Email: amirali1211982@yahoo.com

*Corresponding author

M. Maarefdoust

Department of Mechanical Engineering,
Gonabad Branch, Islamic Azad University, Gonabad, Iran
Email: m_maarefdoust@yahoo.com

Received 27 November 2011; Revised 25 December 2011; Accepted 11 February 2012

Abstract: Conjugated polymer actuators can be employed to achieve micro and nano scale precision, and have a wide range of applications including biomimetic robots, and biomedical devices. In comparison to robotic joints, they do not have friction or backlash, but on the other hand, they have complicated electro-chemo-mechanical dynamics which makes modelling and control of the actuator really difficult. Besides the positive characteristics of these actuators, they have some disadvantages such as creep, hysteresis, highly uncertain and time-varying dynamics. This paper consists of two major parts. In the first part the Takagi-Sugeno (T-S) Fuzzy model is used to represent the uncertain dynamic of the actuator, and the resulted Fuzzy model will be validated using experimental data. In the second part a proportional-derivative fuzzy controller is designed to control the highly uncertain dynamic of conjugated polymer actuator. In order to optimize the performance of fuzzy controller, Genetic Algorithm (GA) is used for tuning the output membership functions. The obtained results show that the designed controller can achieve good performance despite the existence of uncertain actuator dynamics and also it has a better performance than conventional PID controller.

Keywords: Conjugated Polymer Actuators, Genetic Algorithm (GA), Polypyrrole (PPy), Proportional-derivative Fuzzy Controller, T-S Fuzzy Modelling

Reference: A. A. Amiri Moghadam and M. Maarefdoust, (2012) 'Proportional-derivative Fuzzy Control of Conjugated Polymer Actuators', *Int. J. Advanced Design and Manufacturing Technology*, Vol. 5/ No. 2, pp. 7-15.

Biographical notes: **A. A. Amiri Moghadam** is currently pursuing a Ph.D. degree in Mechanical Engineering at Ferdowsi University of Mashhad, Mashhad, Iran. He is a member of Iranian National Elite Foundation, which is the most prestigious academic honor society in the country. His current research interests include Robotics, Mechanical Vibration, Robust Control, Modeling, and Control of Conjugated Polymer Actuators for Application in Micro Manipulation Systems. **M. Maarefdoust** is a Ph.D. student in Ferdowsi University of Mashhad. He is an Instructor at Department of Mechanical Engineering, Islamic Azad University, Gonabad Branch.

1 INTRODUCTION

There is an increasing request for a new generation of actuators which can be used in devices such as artificial organs, micro robots, human-like robots, and medical applications.

Numerous researches has been carried out in an effort to develop new actuators such as shape memory alloys, piezoelectric actuators, magnetostrictive actuators, contractile polymer actuators, and electrostatic actuators [1, 2]. Comparison of these actuators indicates that Conjugated polymer actuators have superior characteristics over others [2, 3].

The main process which is responsible for volumetric change and the resulted actuation ability of the conjugated polymer actuators is Reduction/Oxidation (RedOx). Thus based on different fabrication form, different configuration of the actuators can be obtained namely: linear extenders, bilayer benders, and trilayer benders [3-6]. By applying a voltage to the actuator, the polypyrrole (PPy) layer on the anode side is oxidized while that on the cathode side is reduced. Ions can be transferred inside the Conjugated Polymer Actuators based on two main mechanisms namely diffusion and drift [7]. Since 2000 the Diffusive-Elastic-Metal model (DEM) remains to be the main model which could describe the actuation process in conjugated polymer actuators [7]. Several assumptions are needed to achieve the DEM model such as: 1) the electrical and mechanical parameters of the model are time invariant, 2) there is no coupling between the mechanical and the electrical model, 3) the charge to strain ratio is linear and unidirectional, 4) there is no degradation in the electrical or the mechanical model, 5) the actuator is isothermal. On the other hand the dynamic of the actuator is highly uncertain, and both electrical and mechanical degradation are inevitable during the actuator's lifecycle. Also continuum structure of the DEM model is not suitable from control perspective. The Reticulated Diffusion Model (RD) was proposed by T. A. Bowers in 2002 [8]. This model uses a reticulated network of linear circuit elements. The main advantage of RD over the DEM model is that it can be represented in state space format and is suitable for linear system analysis techniques, but still it cannot take into account system uncertainties based on its Linear Time-Invariant (LTI) structure. In our previous work, we used the Golubev Method [9] to build a suitable model to control the actuator [3]. By taking into account the effects on uncertainties such as variation of the resistance and diffusion coefficient in the modeling, we replaced the dynamic of the actuator

with a family of third order LTI systems. But we did not consider the interaction of these linear systems and this is the starting point in the current paper. In order to solve this problem in this paper the authors propose a Takagi-Sugeno Fuzzy model which can define the relation between local linear systems, and therefore perfectly predict the actuator's behavior under variation of the actuator's parameter. Application of Proportional- Integral-Derivative (PID) controller for a polypyrrole actuator based on a first order model is presented in [10]. PID and adaptive control approaches based on a first order empirical model are demonstrated in [8]. In our previous works we used Robust Control QFT, and parallel distributed compensation (PDC) to control a polypyrrole actuator based on a third order model [3], [11, 12] and in this paper we use a proportional-derivative fuzzy controller. Thus the reminder of the paper is formed as follows:

- 1) First the classic model of the actuator will be reviewed briefly.
- 2) Experimental data will be presented.
- 3) A suitable T-S fuzzy model which can take variation of the actuator's parameter into account, will be obtained.
- 4) Finally a proportional-derivative fuzzy controller will be designed.

2 ELECTRO-CHEMO-MECHANICAL MODELING

The electro-chemo-mechanical model is comprised of two parts, namely the electrochemical model and the electromechanical model.

2.1. Electrochemical Modeling

The electrochemical model relates the input voltage and chemical RedOx reaction inside the PPy actuators. Fig. 1 depicts the electrical admittance model. Based on the Diffusive-Elastic-Metal model, transportation of ions within the polymer is only caused by diffusion [7].

According to Fig. 1 and the Kirchhoff's voltage law one has:

$$I(s) = I_C(s) + I_D(s) \quad (1)$$

$$V(s) = I(s)R + \frac{1}{s.C} I_C(s) \quad (2)$$

where Z_D is the diffusion impedance, C denotes the double-layer capacitance, and R is the electrolyte and contact resistance. Next based on Fig. 2 and the Fick's law of diffusion, diffusion current is:

$$i_D(t) = -F.A.D. \left. \frac{\partial c(x,t)}{\partial x} \right|_{x=0} \quad (3)$$

where A is the surface area of the polymer, F is the Faraday constant, D is the diffusion coefficient, h is the thickness of the PPy layer, and c is the concentration ions.

The current of double-layer capacitance is:

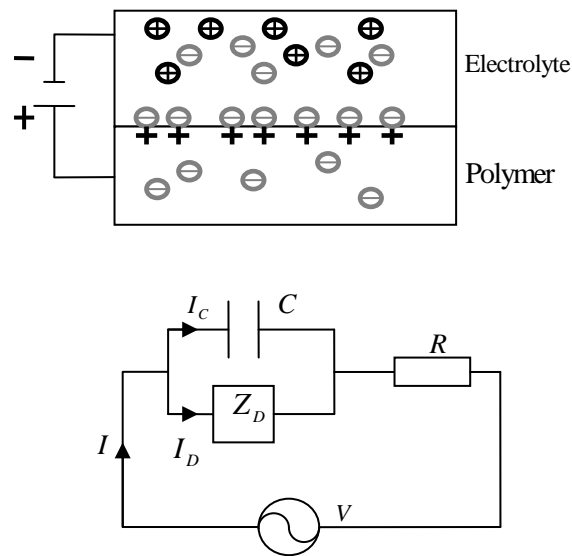

Fig. 1 Description of diffusion and double layer charging and its equivalent electrical circuit

$$i_C(t) = F.A.\delta. \left. \frac{\partial c(x,t)}{\partial t} \right|_{x=0} \quad (4)$$

where δ is the double-layer capacitance thickness, and the diffusion equation is:

$$\frac{\partial c}{\partial t} = D \frac{\partial^2 c}{\partial x^2} \quad 0 < x < h \quad (5)$$

Finally the boundary condition is:

$$\left. \frac{\partial c(x,t)}{\partial x} \right|_{x=h} = 0 \quad (6)$$

Now based on Eqs. (1), (2), (3), (4), (5), and (6), it can be shown that the admittance model ($Y(s) = \frac{I(s)}{V(s)}$) of a conjugated polymer [7].

$$Y(s) = \frac{s \left[\frac{\sqrt{D}}{\delta} \tanh(h\sqrt{s/D}) + \sqrt{s} \right]}{\frac{\sqrt{s}}{C} + R s^{3/2} + R \frac{\sqrt{D}}{\delta} s \tanh(h\sqrt{s/D})} \quad (7)$$

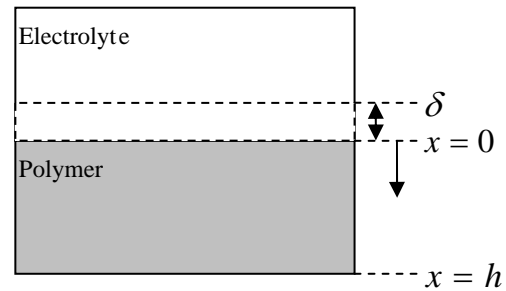

Fig. 2 Description of frame assignment for diffusion

2.2. Electromechanical Modeling

The electromechanical model relates the input voltage and displacement of the PPy actuators. It was shown that the relation between the induced in-plane strain (ϵ_c) and the density of the transferred charges (ρ) is given as Eqs. (8) through (11) [7, 13]:

$$\epsilon_c = \alpha \cdot \rho \quad (8)$$

where α is the strain-to-charge ratio. Thus, the induced stress is:

$$\sigma_c = \alpha \cdot E_{PPy} \cdot \rho \quad (9)$$

where E_{PPy} is the Young's modulus of PPy, and ρ can be achieved in the Laplace domain as below [7, 10]:

$$\rho(s) = \frac{I(s)}{sWLh} \quad (10)$$

where W is the width of the PPy, and L is the length of the PPy. The initial displacement Δy_m is caused by load (m) which can be obtained as below:

$$\Delta y_m = \frac{mgL}{WhE_{PPy}} \quad (11)$$

where m, is the mass of applied load.

Finally based on Fig. 3 and by combining Eqs. (7), (8), and (10) one can obtain the full model between input voltage (V) and output displacement (y) as below [7, 10]:

$$\frac{y(s)}{V(s)} = \frac{\xi}{sR + \frac{1}{C(1 + \frac{\sqrt{D}}{\delta\sqrt{s}} \tanh(h\sqrt{\frac{s}{D}}))}} \quad (12)$$

where

$$\xi = \frac{1}{WLh} \quad (13)$$

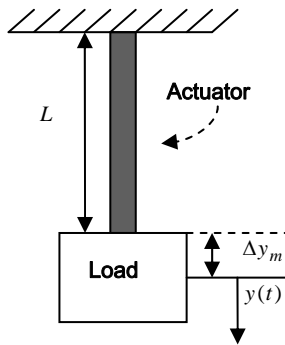

Fig. 3 Description of frame assignment for displacement of the actuator

By replacing the term \tanh with its equivalent series in Eq. (13) the actuator model is [7]:

$$\frac{y(s)}{V(s)} = \frac{\xi}{sR + \frac{1}{C(1 + \frac{2D}{h\delta} \sum_{n=0}^{\infty} \frac{1}{s + \pi^2(2n+1)^2 D(2h)^{-2}})}} \quad (14)$$

3 EXPERIMENTAL DATA

The experimental data has been obtained from [9]. Polypyrrole was used for test as Electroactive polymers (EAPs) material and the electrolyte used was 0.1 M tetraethylammonium hexafluorophosphate (TEAPF6) in propylene carbonate (PC). The polymer film is held in the test fixture with clamps at both ends. The reference electrode used in the experiment was Ag/AgClO₄. Mechanical loading is exerted by a voice coil actuator (Bruel & Kjaer Minishaker 4810).

For the purpose of isotonic testing, a force transducer feedback control is used. The position sensor is photodiode (PPS-DL700-7PCBA) with a resolution of 250 nm. Fig. 4 depicts the testing equipment.

Typical values of physical parameters are presented in table 1.

Table 1 Values of physical parameters

Parameter	Value
D	$1 \times 10^{-12} \text{ m}^2 / \text{s}$
h	19 μm
R	800 Ω
δ	25nm
C	$5.33 \times 10^{-5} \text{ F}$

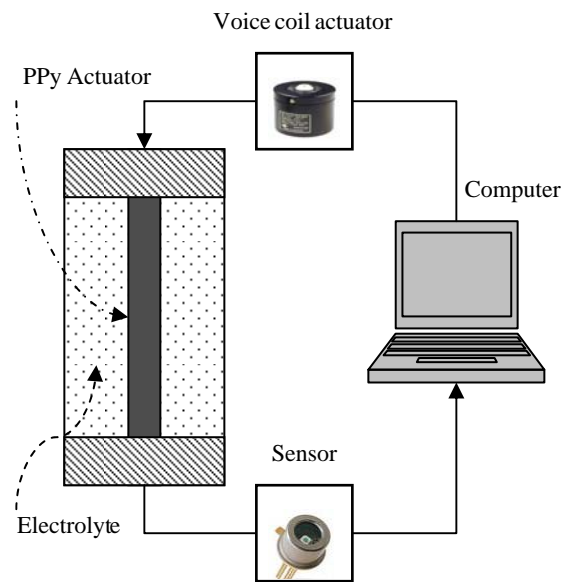

Fig. 4 Schematic of the experimental setup

3.1. Isotonic testing based on voltage input

The voltage was increased in steps of 0.1 V starting from about -0.5 V vs. Ag/AgClO₄ which is the potential of the zero charge (PZC).

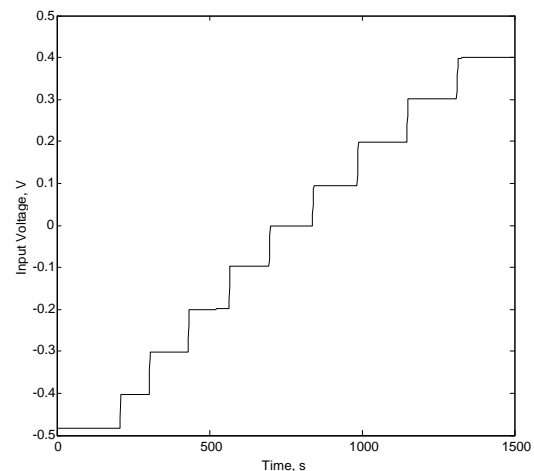

Fig. 5 Input voltage applied to PPy actuator

Subsequent to each potential step the current was permitted to drop down to 30 μA before the next step was applied. This value was reported to capture considerable section of the time response of the polymer electrical domain [8].

Fig. 5 shows the potential input and Fig. 6 depicts the current output of the actuator.

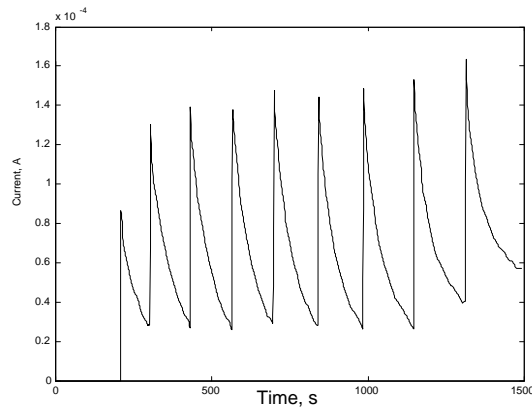

Fig. 6 Experimental current output

4 T-S FUZZY MODELING

Fuzzy logic was born in 1965 by Zadeh [14]. Nowadays, it is widely used in industrial applications. Fuzzy logic can model the nonlinear relationship between inputs and outputs. It can simulate the operator’s behavior without using mathematical models [15]. It is a method that transfers human knowledge into mathematics. Incomplete, vague and/or inaccurate expert knowledge is formulated with the aid of if-then rules. Each rule explains a nonlinear relationship between inputs and outputs. All rules together define a linguistic model [16, 17]. The T–S fuzzy system is one of the most popular systems in model-based fuzzy control. It is described by fuzzy IF-THEN rules that represent local linear input–output relations of a nonlinear system. The T–S model is capable of approximating many real nonlinear systems, e.g., mechanical systems, electrical systems, chemical systems and so on, because it uses linear models in the consequent part, linear control theory can be applied for system analysis and design consequently, based on the (PDC) approach [18]. The basic feature of T-S fuzzy modeling is to represent the local dynamic of the system with a linear model, and the overall fuzzy model is a combination of this linear model. One can represent the local linear systems as follows:

$$\begin{cases} \dot{x}_i(t) = A_i x(t) + B_i u(t) \\ y = C_i x(t) \end{cases} \quad i=1,2,\dots,r \quad (15)$$

where (r) is the number of selected points for linearization. We consider the following T–S fuzzy system with (r) plant rules that can be represented as Plant Rule i:

If \tilde{z}_1 is \tilde{A}_1^i and \tilde{z}_2 is \tilde{A}_2^i and, ..., and \tilde{z}_p is \tilde{A}_p^i Then,

$$\begin{cases} \dot{x}_i(t) = A_i x(t) + B_i u(t) \\ y = C_i x(t) \end{cases} \quad (16)$$

where r is the total number of rules, \tilde{Z} is the premise input vector and \tilde{A}_p^i is a fuzzy set, then the fuzzy system can be given as:

$$\dot{x}(t) = \frac{\sum_{i=1}^r (A_i x(t) + B_i u(t)) \mu_i(z(t))}{\sum_{i=1}^r \mu_i(z(t))} \quad (17)$$

Or

$$\dot{x}(t) = \left(\sum_{i=1}^r A_i h_i(z(t)) \right) x(t) + \left(\sum_{i=1}^r B_i h_i(z(t)) \right) u(t) \quad (18)$$

where $\mu_i(z(t))$ is the fuzzy membership function and h can be defined as below:

$$h^T = [h_1, \dots, h_r] = \left[\frac{1}{\sum_{i=1}^r \mu_i(z(t))} \right] [\mu_1, \dots, \mu_r] \quad (19)$$

Since the term tanh in Eq. (12) is not suitable for real time control of the actuator and this equation cannot take into account the system uncertainties. In this paper the T–S fuzzy model is used for the purpose of modeling. As we have shown in [3] a third order model can greatly describe the actuation process. Experimental data shows that a LTI model based on initial physical parameter of the actuator can not accurately predict the behavior of the actuator, thus based on observation of experimental data we consider three zones for the actuation process. These zones which somehow indicate the variation of the physical parameter of the actuator are chosen as the premise of our T-S fuzzy model. We name these zones: initial, middle, and final zones. Corresponding membership functions for these zones are depicted in Fig. 7. For example the linear system in the initial zone is as below:

$$A_1 = \begin{bmatrix} -0.918 & -0.087 & 0 \\ 0.125 & 0 & 0 \\ 0 & 0.125 & 0 \end{bmatrix} ; B_1 = \begin{bmatrix} 0.0039 \\ 0 \\ 0 \end{bmatrix}$$

$$C_1 = \begin{bmatrix} 0 & 0.0061 & 6.68 \times 10^{-6} \end{bmatrix}$$

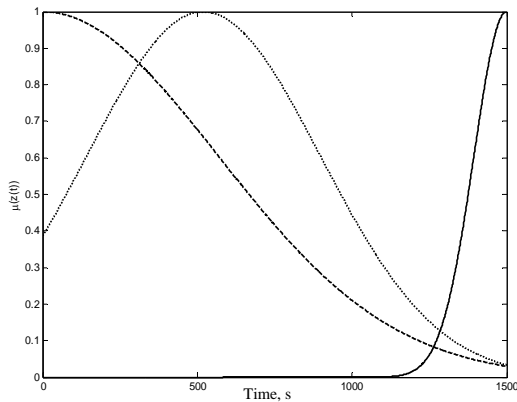

Fig. 7 Membership function for the fuzzy zones

Since our model is going to be used as a multipurpose model and be able to satisfy the rules needed to implement the PDC controlling approach, the polypyrrole actuator dynamic must be controllable. This can be checked using the controllability test matrix Φ_c .

$$\Phi_c = \begin{bmatrix} B & AB & \dots & (A)^{n-1}B \end{bmatrix}$$

$$= \begin{bmatrix} 0.0039 & -0.00358 & 0.003249 \\ 0 & 0.00048 & -0.00044 \\ 0 & 0 & 0.000061 \end{bmatrix}$$

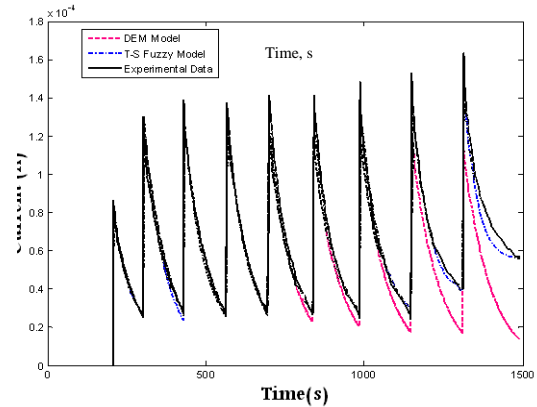
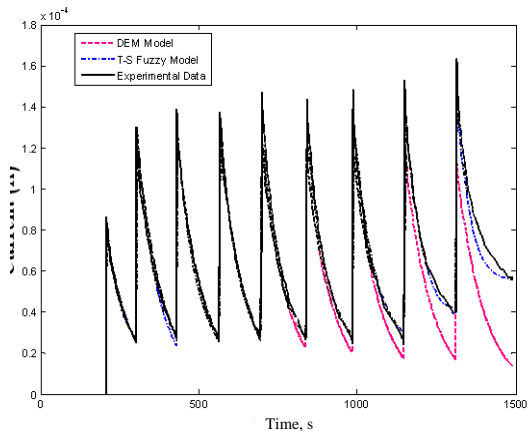

Fig. 8 Comparison of experimental data with the T-S fuzzy model and DEM model

Clearly the rank of Φ_c is three, thus the system is controllable.

Comparison of experimental data with the T-S fuzzy model and DEM model is shown in Fig. 8.

5 DESIGN OF FUZZY CONTROLLER

A proportional-derivative fuzzy control system is used [19]. The fuzzy control system has two inputs, namely error, and differential of error. The linguistic values NB, NM, NS, ZE, PS, PM, and PB are the same for inputs and output. The fuzzy inference system is the Product Inference Engine with the following parameters:

- (i) individual-rule based inference with union combination,
 - (ii) Mamdani's product implication,
 - (iii) algebraic product for all the t-norm operators and max for all the s-norm operators.
- We also used singleton fuzzifier, center average defuzzifier, and Gaussian membership functions. For example the error membership function is shown in Fig. 9.

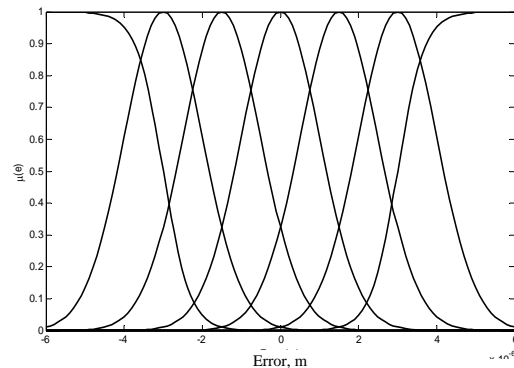

Fig. 9 Membership function for error

Assuming that there are seven membership functions on each input universe of discourse, there are 49 possible rules which are shown in table 2.

Table 2 Complete set of rules for Fuzzy controller

U_i	\dot{E}_i	NB	NM	NS	ZO	PS	PM	PB
E_i	NB	NB	NB	NB	NM	NS	NS	ZO
	NM	NB	NB	NM	NM	NS	ZO	PS
	NS	NM	NM	NS	NS	ZO	PS	PM
	ZO	NM	NM	NS	ZO	PS	PM	PM
	PS	NM	NS	ZO	PS	PM	PM	PB
	PM	NS	ZO	PS	PM	PM	PM	PB
	PB	ZO	PS	PM	PM	PM	PB	PB

Genetic Algorithm (GA) is used to optimize the performance of the fuzzy controller [20]. One can optimize a fuzzy system in three ways: 1) Optimization of membership functions, 2) Optimization of rule base, 3) Optimization of both membership functions, and rule base. As we know there is a redundancy in optimization of both membership functions and rule base, thus here we choose to optimize the membership functions. Especially we used GA for tuning the output membership functions.

The fuzzy controller output surface is depicted in Fig. 10. Fig. 11 shows the fuzzy controller block diagram.

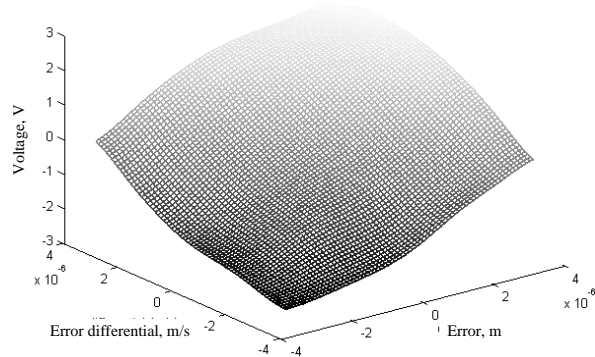

Fig. 10 Fuzzy controller output surface

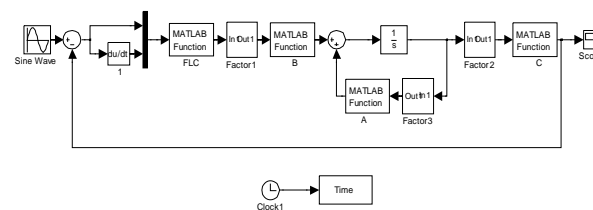

Fig. 11 Fuzzy controlling block diagram

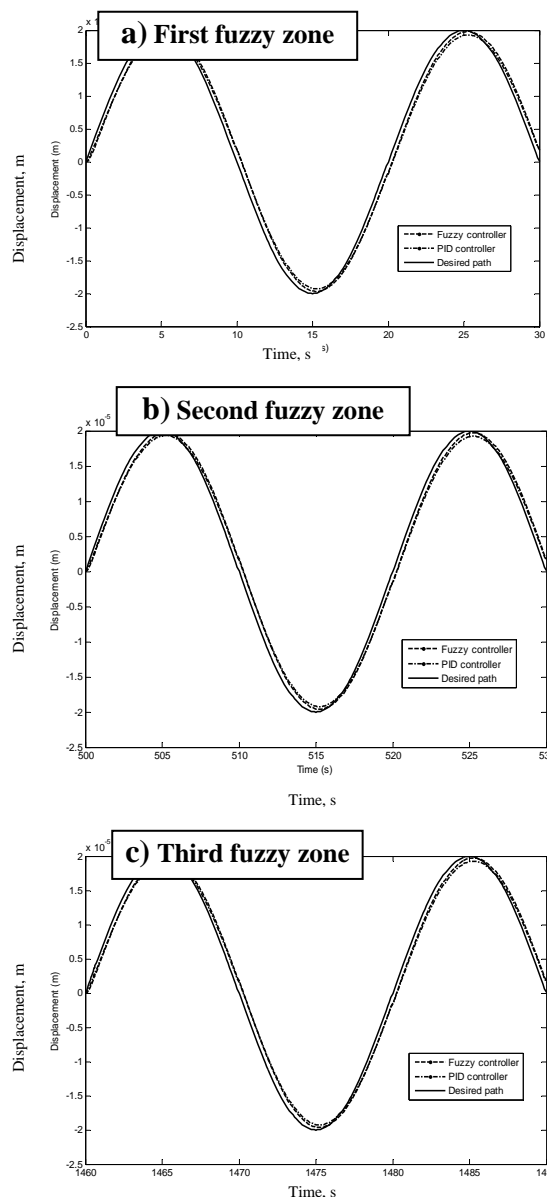

Fig. 12 Tracking problem for a sin wave

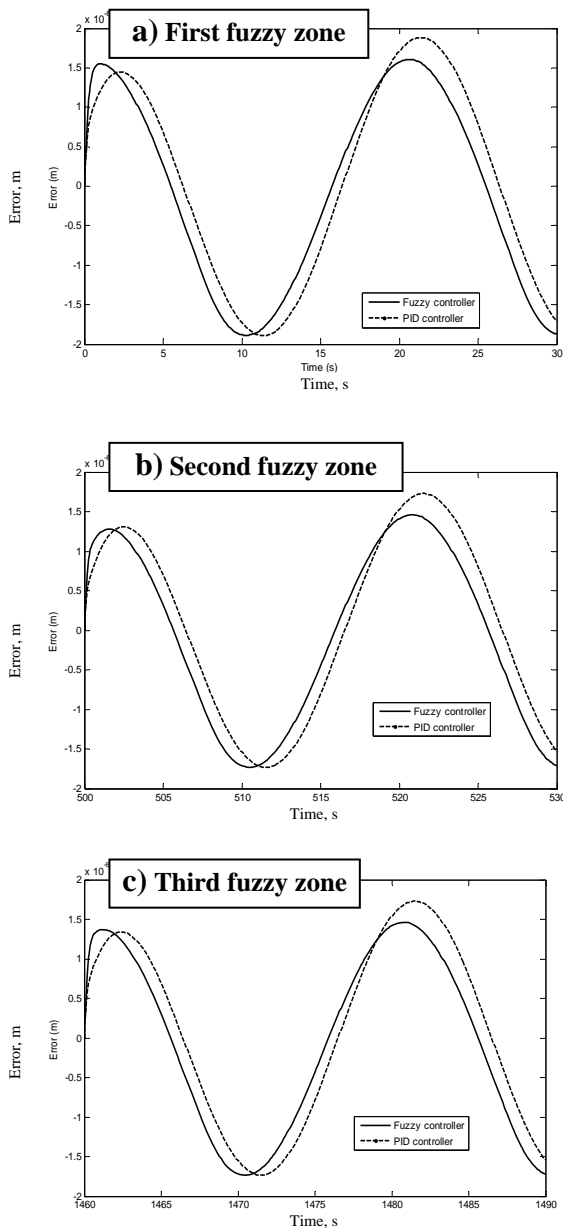

Fig. 13 Tracking error

In order to show the effectiveness of the designed fuzzy controller we run simulations for tracking problems in all three fuzzy zones. Figs. 12-a, 12-b, and 12-c show the tracking problem for the reference input $R=2 \times 10^{-5} \sin(0.1\pi t)$ m. Figs. 13-a, 13-b, and 13-c depict the tracking error, while Figs. 14-a, 14-b, and 14-c illustrate the state variables in 3 fuzzy zones.

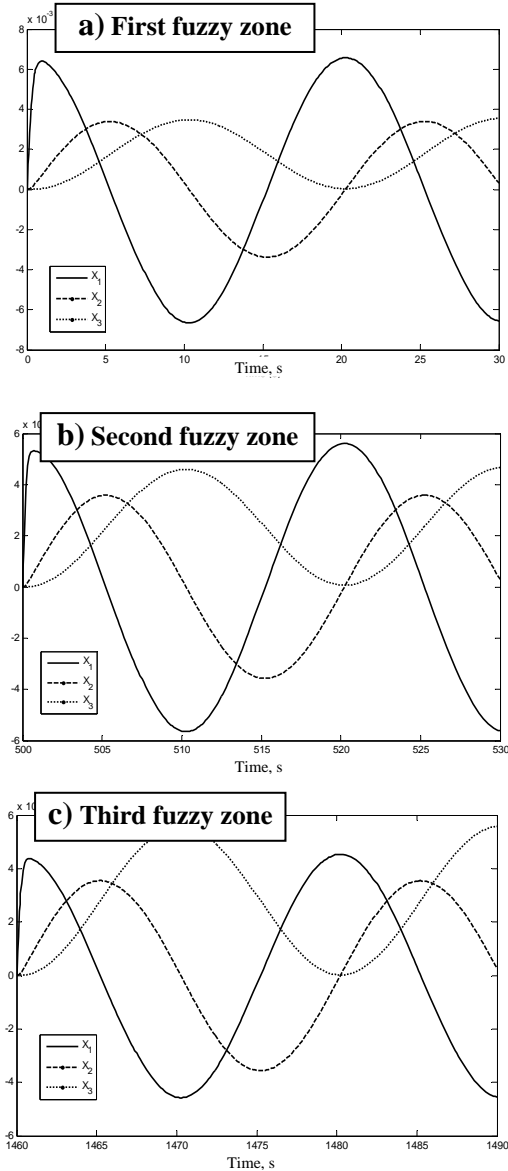

Fig. 14 State variables

6 CONCLUSION

The main contributions of this paper are:

- (i) In the modeling phase based on the application of

T-S fuzzy modeling, the system uncertainties are incorporated into the model. Comparison of experimental data with the proposed T-S fuzzy model indicates that, it could greatly predict the actuation process over variation of the actuator physical parameter.

Generally we can state that by proposing the T-S fuzzy model, the obstacles behind conventional modeling

techniques (DEM, RD) such as model parameter variation and other constraints and assumptions are eliminated successfully.

(ii) In the controlling phase we used proportional-derivative fuzzy controlling approach. G.A. was successfully applied for optimization of fuzzy controller. Results of simulations over all three fuzzy modeling zones show that the proposed controlling scheme has consistent tracking performance despite the existence of uncertainty in the dynamic of the actuator. Comparison of the proposed fuzzy controller with conventional PID controller in tracking problem shows the effectiveness of our design. It seems that the recent work can challenge our previous attempt for implementation of Golubev and QFT. This can be from modeling and controlling point of view, which could be a title for the next bench mark research.

REFERENCES

- [1] Hollerbach, J. M., Hunter, I. W. and Ballantyne, J. A., Comparative Analysis of Actuator Technologies for Robotics. MIT press, 1999, pp. 299–342.
- [2] Ian, W., Hunter and Serge Lafontaine, “A Comparison of Muscle with Artificial Actuators”, Solid-State Sensor and Actuator Workshop, 5th Technical Digest, IEEE 1992, pp. 178–185.
- [3] Torabi, K., Moavenian, Z. M., Amiri Moghadam, A. A. and Amiri Moghadam, A. H., “Modelling and Control of Conjugated Polymer Actuators Using Robust Control QFT”, 17th Annual International Conference on Mechanical Engineering, ISME 2009, pp. 181-190.
- [4] Della Santa A., De Rossi, D., and Mazzoldi, A., “Characterization and Modeling of a Conducting Polymer Muscle-like linear Actuator”, Smart Materials and Structures, Vol. 6, 1997, pp. 23–34.
- [5] Smela, E., Inghanas, O., and Lundstrom, I., “Controlled Folding of Microsize Structures”, Science, Vol. 268, 1995, pp. 1735–1738.
- [6] Kaneto, K., Kaneko, M., Min, Y. and MacDiarmid, A. G. “Artificial Muscle: Electromechanical Actuators Using Polyaniline Films”, Synthetic Metals, Vol. 71, No. 1-3, 1995, pp. 2211–2212.
- [7] Madden, D. W., “Conducting Polymer Actuators”, Ph.D. Thesis, MIT, 2000.
- [8] Bowers, Thomas A., “Modeling, Simulation, and Control of a Polypyrrole-based Conducting Polymer Actuator”, M.Sc. Thesis, MIT, 2004.
- [9] Golubev, B. and Horowitz, I. M., “Plant Rational Transfer Function Approximation from Input-output Data”, International Journal of Control, Vol. 36, No. 4, 1982, pp. 711-723.
- [10] Madden, P. G. A., “Development and Modeling of Conducting Polymer Actuators and the Fabrication of a Conducting Polymer Based Feedback Loop”, Ph.D. Thesis, Massachusetts Institute of Technology, 2003.
- [11] Amiri Moghadam, A. A., Torabi, K. and Moavenian, M., “Finite Element Modeling and Robust Control of Fast Trilayer Polypyrrole Bending Actuators”, International Journal of Applied Electromagnetics Mechanics, Vol. 35, 2011, pp. 281–305.
- [12] Amiri-M, A. A., Moavenian, M. and Torabi, K., “Takagi-sugeno Fuzzy Modelling and Parallel Distribution Compensation Control of Conducting Polymer Actuators”, Journal of Systems and Control Engineering, Vol. 224, 2009, pp. 41-51.
- [13] Otero, T. F. and Sansinena, J. M. “Bilayer Dimensions and Movement Inartificial Muscles”, Bioelectrochemistry and Bioenergetics, Vol. 42, No. 2, 1997, pp. 117–122.
- [14] Zadeh, L. A., Fuzzy Sets, Inform. Control 8, 1965, pp. 338–353.
- [15] Bersini, U. and Cacciabue, P. C., Simulating Operator Behavior in Process Control by a Goal Oriented Approach and Fuzzy Logic Formalism, Pergamon Press, New York, 1987.
- [16] Zimmerman, H. J., Fuzzy Set Theory and Its Applications, Springer, 2001.
- [17] Li-Xin Wang, A Course in Fuzzy Systems and Control, Prentice-hall PTR, 1997.
- [18] Tanaka, K. and Wang, H. O., Fuzzy Control Systems Design and Analysis: Linear Matrix Inequality Approach. New York: Wiley, 2001.
- [19] Kevin, M. and Passino, Stephen Yurkovich, Fuzzy Control, Addison Wesley Longman, Inc. 1998.
- [20] Jang, J. S. R., Sun, C.T., Mizutani, E., Neuro-fuzzy and Soft Computing, A Computational Approach to Learning and Machine Intelligence. Prentice-hall, Inc. 1997.