

# Influences of Blank Holder Force in The Multi-Step Deep Drawing Process of Aluminum Sheets

**Sajad Bakhtiari**<sup>1</sup>

Department of Mechanical Engineering,  
Shahid Rajaee Teacher Training University, Tehran, Iran  
E-mail: sajad.bakhtiari2186@yahoo.com

**Seyed Jalal Hashemi**<sup>2, \*</sup>

Department of Mechanical Engineering,  
Faculty of Enghelab-e Eslami, Tehran Branch, Technical and Vocational  
University (TVU), Tehran, Iran  
E-mail: J\_hashemi@tvu.ac.ir  
\*Corresponding author

**Amir Hossein Roohi**<sup>3</sup>

Department of Mechanical Engineering,  
Faculty of Industrial and Mechanical Engineering, Qazvin Branch, Islamic Azad  
University, Qazvin, Iran  
E-mail: Amir.roohi@qiau.ac.ir

**Received: 5 October 2019, Revised: 13 December 2019, Accepted: 23 December 2019**

**Abstract:** In recent decades, the use of aluminium alloys is developed in the automotive industry with regard to the need for lightweight and anti-corrosion components, one of which is AA7075 Al alloy. In this study, the multi-step deep drawing process of AA7075 aluminium sheets under various blank holder forces is investigated through a numerical simulation and is then validated with experimental results. Simulations were conducted by ABAQUS finite element software, and the influences of the blank holder force on the wrinkling height, rupture occurrence and thickness distribution of the sheet were studied. The optimum amount of blank holder force at each drawing step is determined so that the height of wrinkling, and the thinning percentage do not exceed the permissible value. Based on the results, the blank holder force magnitude should be considered descending during the four successive steps to achieve more uniform thickness distribution, and also the wrinkling height could be reduced by increasing the blank holder force in the analysed force range. The optimum amount of blank holder force in the four drawing steps was 28000, 2500, 1500 and 600 N, respectively. In general, the minimum thickness was created in the corner of the punch. The results also showed that an excessive increase in the blank holder force in order to eliminate the wrinkling caused the thinning percentage to increase. Finally, a good accordance between the experimental and numerical results was observed.

**Keywords:** Blank Holder Force, Deep Drawing, Finite Element Analysis, Thickness Distribution

**Reference:** Sajad Bakhtiari, Seyed Jalal Hashemi, and Amir Hossein Roohi, "Influences of Blank Holder Force in The Multi-Step Deep Drawing Process of Aluminum Sheets", Int J of Advanced Design and Manufacturing Technology, Vol. 13/No. 3, 2020, pp. 51–57.

**Biographical notes:** **Sajad Bakhtiari** received his MSc in Mechanical Engineering from Shahid Rajaee Teacher Training University. His current research interest includes sheet metal forming processes. **Seyed Jalal Hashemi** is Assistant Professor of Mechanical Engineering at Faculty of Enghelab-e Eslami, Iran. He received his PhD in Mechanical Engineering from Tarbiat Modares University of Iran. His current research focuses on sheet metal forming and powder metallurgy. **Amir Hossein Roohi** is Assistant Professor of Mechanical engineering at Qazvin Islamic Azad University (QIAU). He received his PhD in Mechanical Engineering from Tarbiat Modares University. His current research focuses on sheet metal forming and material characterization.

---

## 1 INTRODUCTION

---

The Deep Drawing (DD) process is applied for mass production of various components for many applications such as automotive industry. Deep drawing is a process in which a sheet, usually controlled by a compression plate (i.e. blank holder), is drawn by a punch into the die and forms a final shape (i.e. the product), whose thickness is about the initial sheet thickness [1]. Determining the appropriate blank holder force during the process is one of the most important parameters of DD, which low enough forces could cause wrinkling and excessive high forces causes rupture in the sample [2]. High strength aluminum and magnesium alloys, with a good strength-to-weight ratio and corrosion resistance, are good substitutes for steel alloys in the automotive industry. The main disadvantage of these alloys is their low formability at the room temperature and the high cost of these materials [3]. In order to solve the low formability problem, a number of steps could be considered (that is, dividing a whole desired forming magnitude into several steps) in which the sheet is annealed after each forming step, and then to continue the next drawing step. This strategy results in better formability. However, another way to improve the formability of these alloys is to conduct the hydroforming process on them at elevated temperatures [4]. Numerous research has been performed on single-step “conventional” deep drawing processes, however limited research is present on the multi-step DD process: Choi et al. [5] have developed an intelligent software to design and simulate the drawing steps of axially symmetric parts.

This software could model the final shape of the sample, and then with the determination of the sheet material parameters and selection of the production method would specify the different drawing steps pre-forms; these steps includes the first step of the initial sheet dimension calculation to the final shape of the product. The pre-form modification was also considered in their model. Sheng et al. [6] have studied the drawing process of a particular product in a multi-step process and predicted the possible defects of the design by using finite element simulation. Then, the final design of the various drawing steps is carried out by modifying the initial design. The accuracy of their design method has been validated with the corresponding experimental results. Li et al. [7] studied the influences of some process parameters, including pre-forming and pressure path, in multi-pass hydrodynamic DD process of aluminum alloys. This study specified the optimum process conditions as well as the identification of the wrinkling and tearing pattern during the process. Sivasankaran et al. [8] modelled the wrinkling phenomena in a deep drawing process using neural networks. They examined different types of annealed

aluminum sheets when drawn through a conical die. In general, given the consistency of numerical modeling and experimental results, this model could be utilized to analyze and predict the onset of wrinkling. Tikhovskiy et al. [9] investigated the earing of AA5754 aluminum alloy sheets with TCCS-FEM approach during the DD process. This study consisted an experimental validation for the performed simulations, as well. Liu et al. [10] implemented an anisotropic model in a FEM software in order to recognize the behavior of AA3104-H19 sheets through the high-speed deep drawing process. Also, using the non-round blanks to minimize the ears height in the cup products are proposed. Qayyum et al. [11] have focused on the anisotropy of the material and its influences on the multi-step DD process of AISI SS304 L with intermediate annealing treatments. Proubet and Baudelet [12] published the rupture criteria of aluminum alloys during the deep drawing process. Using process simulation and analytical methods they found the effects of mesh density and coefficient of friction on the accuracy of the simulation results. Furthermore, Zhang et al. [13] developed a computer-aided process planning for designing the pre-forms in non-asymmetric multi-step deep drawing process. Abdelmaguid et al. [14] used a dynamic approach to reduce the number of drawing steps as well as the number of annealing treatment. This also has led to obtain the optimum thickness distribution in the product. Pacheco et al. [15] carried out a numerical simulation to investigate the deformation behavior of the sheet in the three-step DD process.

As it is obvious in the literature review, no research has been conducted to investigate the effect of the blank holder force at different steps of a multi-step deep drawing on the thickness distribution and wrinkling of the products. In this paper, the four-step DD process of AA7075 aluminum sheet is simulated in which annealing of the formed sample is performed after the first and third steps. The optimum blank holder force is specified by varying the force at each step. Based on the numerical simulation results, the amount of blank holder force is determined in order to obtain the lowest wrinkling height in the wall section of the product as well as the best thickness distribution. In order to reduce costs, the annealing process is performed only after the first and third drawing steps. Finally, the numerical results are validated with the experimental results, which show a very good accordance in this regard.

---

## 2 NUMERICAL SIMULATION OF THE MULTI-STEP DD PROCESS

---

The final sample, as a stepped product, and its dimensions are shown in “Fig. 1”. The process components are modelled in ABAQUS/CAE software and the simulation is conducted using

ABAQUS\Explicit analysis. The geometry of the punch, die and blank holder used in the four-step DD process is considered as reported in [16]. Initial sheet thickness and its diameter were 1.5 mm and 145 mm, respectively. Aluminum sheets are modelled as a deformable part, whereas the die components are modelled as a rigid one.

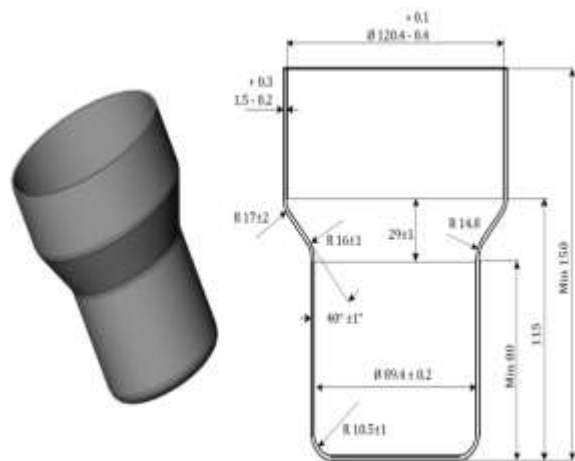

Fig. 1 Final product and its dimensions.

The partitioning of the sheets is performed, illustrated in “Fig. 2 (a)”, in order to achieve a more uniform mesh distribution. As well, S4R element types are used in the meshing process (“Fig. 2 (b)”). The mesh study was performed to specify the optimum number of the elements required for each sheet: the coarse mesh was first considered and then the mesh sizes were reduced, and the accuracy of the results was compared. As a result, the mesh size of 2 mm was selected. The time period of each step of the process was selected equal to 0.05 sec, based on the consideration of force and energy history.

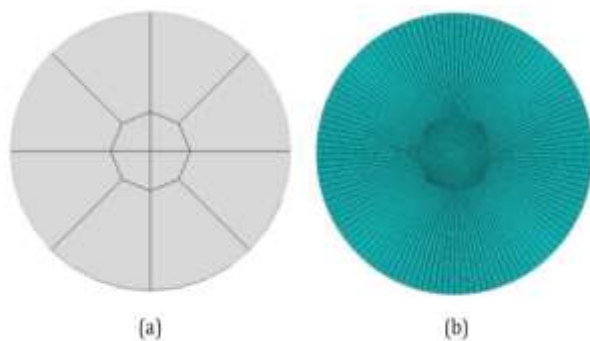

Fig. 2 (a): Sheet partitioning; and (b): sheet meshing.

The coefficient of friction at the contact surfaces of the sheet with die and blank holder is 0.05, and at the contact surface of the sheet with the punch is 0.1. In this study, AA7075-0 aluminum alloy sheets are considered to be homogeneous and isotropic. The sheet different properties are listed in “Table 1”.

Table 1 Geometrical, physical and mechanical properties of the sheet

Property	Unit	Magnitude
Thickness	[mm]	1.5
Density	[g/cm <sup>3</sup> ]	2.8
Poisson’s ratio	-	0.3
Yield stress	[MPa]	138
Ultimate tensile stress	[MPa]	250
Young’s modulus	[GPa]	71.7

The drawing steps are simulated as a multi-step progressive process, which after pre-forming at the first die, the sheet is then placed in the second and so on. It is worth mentioning that the annealing treatment is performed after the first and third steps and thus, the sheet properties are recovered. The die model of the four-step deep drawing process is shown in “Fig. 3”.

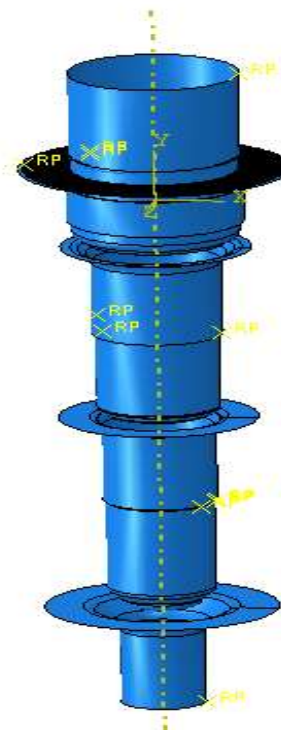
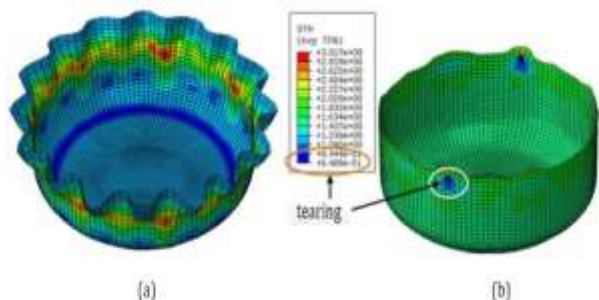

Fig. 3 Four-step deep drawing simulated model.

The criteria of wrinkling, and tearing are specified based on the reference [17]. Accordingly, when the wall wrinkle height is less than 20% of the initial thickness, the product is assumed to be standard and acceptable, and when the maximum thinning in the sheet exceeds 25% of its initial thickness, the sheet is considered as a torn product. Therefore, whenever the wrinkling height in this study reaches 0.3 mm or less, the sheet has no defect and is accepted. As well, due to the initial thickness of the sheet, the maximum accepted thinning is 0.375 mm.

### 3 RESULTS AND DISCUSSION

In order to investigate the effect of the blank holder force on the wrinkling height during the first step of the process, at first a simulation without applying the blank holder force and then, by applying the different forces of 4000, 10000, 16000, 24000, 28000, 30000 and 32,000 N were performed. It is worth mentioning that only the blank holder forces were changed and all other parameters were kept constant through the simulations. After the simulation is conducted, the wrinkling height of the formed piece was calculated. According to the results, when the blank holder force is not applied, the highest wrinkling height is observed which decreases with increasing the force. However, excessive blank holder force prevents the sheet from flowing into the die, which leads to local thinning and as a result, tear phenomena happens. Figure 4(a) shows the sheet wrinkling when no blank holder force is applied. Up to the forces of 14000 N because of the excessive wrinkling at the end of the drawn wall of the sample, an excessive thinning is observed, which results in tearing. Figure 4(b) shows an example of above-mentioned defected samples. When the force reaches 16000 N, the wrinkling height is reduced and this defect disappears at the force of 18000 N as the wrinkling height reaches the standard limit.

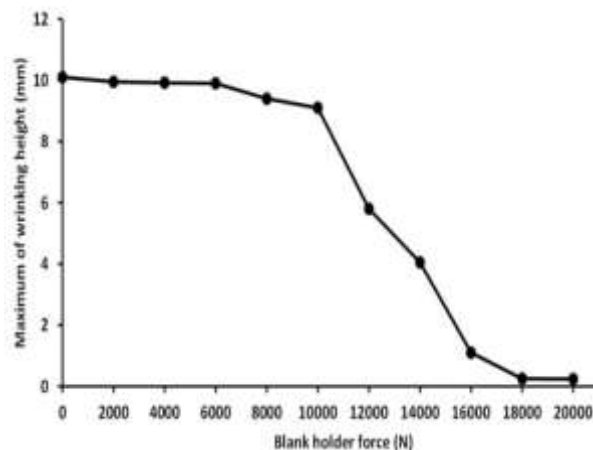

**Fig. 4** (a): Wrinkling observed in the first step of the process without applying the blank holder force; and (b): tearing of the sheet.

Figure 5 depicts the variations of maximum wrinkling height as the die force changes. It is obvious that at a blank holder force of 18000 N, a significant decrease in the wrinkling height happens, where reaches the magnitude of 0.25 mm; this is an acceptable magnitude according to the wrinkling criterion.

According to “Fig. 5”, the highest wrinkling height is when no blank holder force is applied. At forces of less than 10000 N, the sheet overcomes the blank holder force when drawn into the die and pulls the blank holder aside, which causes the sheet to wrinkle. As the blank holder force increases, it squeezes the sheet into the die surface (i.e. as a normal pressure force) and the wrinkling height gradually decreases. Finally, at a blank

holder force of 18000 N, the wrinkle height is 0.25 mm, which is in the acceptable limit according to the wrinkling criterion.



**Fig. 5** Wrinkling height vs. blank holder force at the first step of the process.

Subsequently, the blank holder force is increased to obtain the best thickness distribution with the consideration of this fact that the wrinkling is maintained in the acceptable limit. Since the shape of the sample is symmetrical, a path is selected from the centre to the edge of the sheet, where at the end of the first step of the process, the thickness distribution over this path is compared as the different forces are applied. The mentioned path is shown in “Fig. 6”.

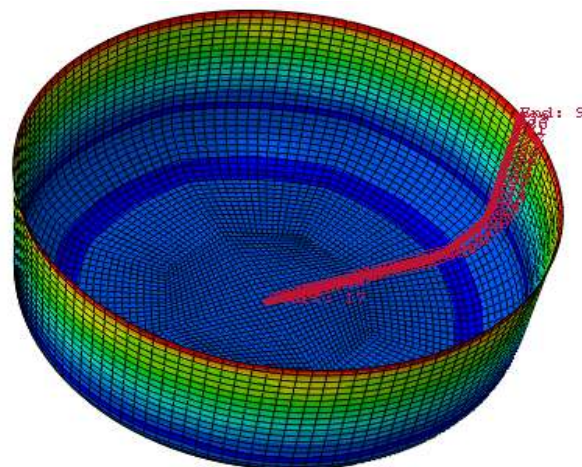

**Fig. 6** The selected path to measure the thickness distribution.

The thickness distribution of the first step under different blank holder forces is illustrated in “Fig. 7”. According to the diagram, the thickness at the bottom of the sample is almost constant due to the friction between the sheet and the punch and is increasing in the area near the edge of the sample. The most significant decrease in the sheet

thickness happens at the contact area between the beginning and end of the punch profile with sheet, where there are points on the bottom and wall of the sample. These are shown in the diagram at 80 and 110 mm from the center point, respectively. According to “Fig. 7”, when the blank holder force is 18000 N, the highest thinning value is observed at the two above-mentioned points, especially the point on the wall. As the force increases the thinning decreases gradually. This decrease in thinning continues until the force reaches 28000 N. As the force exceeds 28000 N, the blank holder prevents the sheet from flowing into the die and the sheets start to experience the thinning phenomenon again. If blank holder force increases significantly, the sheet could be torn. Sheet wrinkling height at the blank holder force of 28000 N is equal to 0.25 mm, which is less than 20% of the initial sheet thickness (wrinkling criterion). Also, the minimum thickness value in this force is equal to 1.4 mm, which is acceptable according to the tear criterion. Thus, the sheet behaves the best at 28000 N with the consideration of both wrinkling and tear criteria. As a result, this force is considered as the optimum force at the first step.

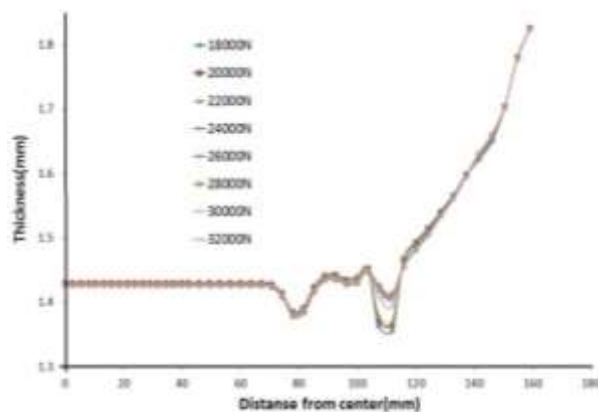

Fig. 7 Thickness distribution of the sheet as a function of different blank holder forces at the first step of the process.

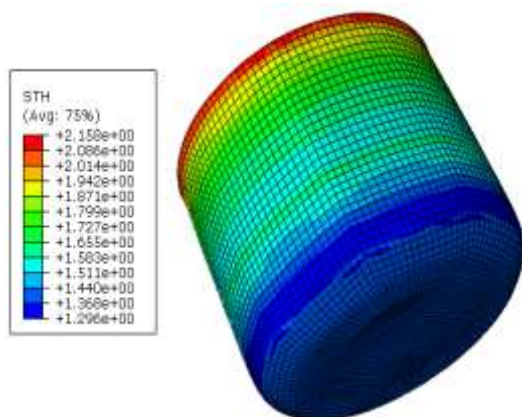

Fig. 8 The sheet thickness distribution after performing the second drawing step.

In the second step of drawing and after annealing the sheet, the changes of the wrinkling height with applying different blank holder forces were investigated. The results show that at the force of 2500 N, the wrinkling height reaches 0.22 mm, which is less than 25% of the initial thickness. Increasing the blank holder force with the magnitude of more than 2500 N at this step causes further thinning and the sheet rupture. As a result, this force value is considered as the optimum value of the blank holder force during the second step. The thickness distribution of the product is shown in “Fig. 8”.

In the third step, the blank holder force of 500 N reduces the wrinkling height by 0.3 mm. Also, the thickness distribution of the product after experiencing the third drawing step at the forces greater than 500 N is shown in “Fig. 9”.

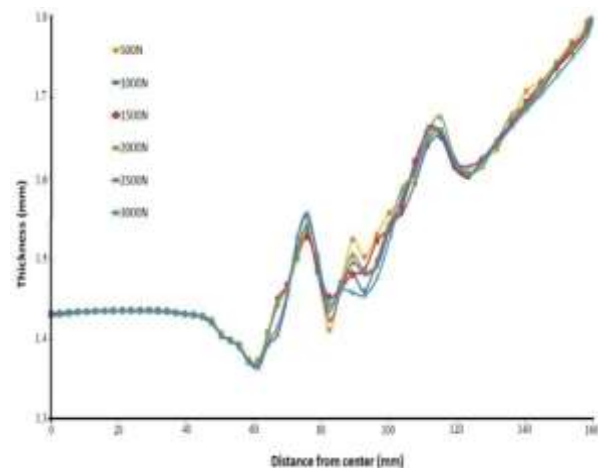
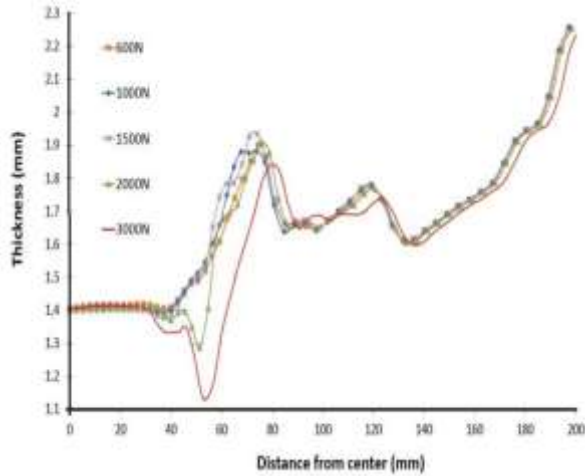

Fig. 9 The thickness distribution of the sheet at the end of third drawing step.

The areas of the sheet with the most thinned zones are located at the points 45 to 80 mm from the centre point. The maximum thinning at this zone (especially the end point of this range) is when the force is equal to 500 N. At the forces of 1000 and 1500 N, the amount of thinning decreases and the final sheet thickness is almost the same as the initial sheet thickness. From a force of 1500 N or more, the increase in force causes a reverse result. In fact, an increase in blank holder force results in a further thinning of the mentioned area by preventing the sheet from flowing into the die. As in the previous steps, the thickness at the bottom of the piece is constant and increasing at the edges at all forces (“Fig. 9”). Also, because the diameter change from the second to the third step is small, the thinning of the sheet in the corner of the punch is almost the same at all forces and the main difference is observed at the endpoints of the corner of the punch. Therefore, the sheet has the best thickness distribution at a force of 1500 N. The minimum sheet thickness at this force is 1.36 mm which is still acceptable according to the tearing criterion.

In the fourth forming step, the 600 N blank holder force eliminates the wrinkling. As shown in “Fig. 10”, an increase in the force more than 600 N causes an increase in the thinning of the sheet at the edge of the punch. The final product formed by the 600 N blank holder force in the fourth step is shown in “Fig. 11”.



**Fig. 10** The thickness distribution of the sheet at the end of fourth drawing step.

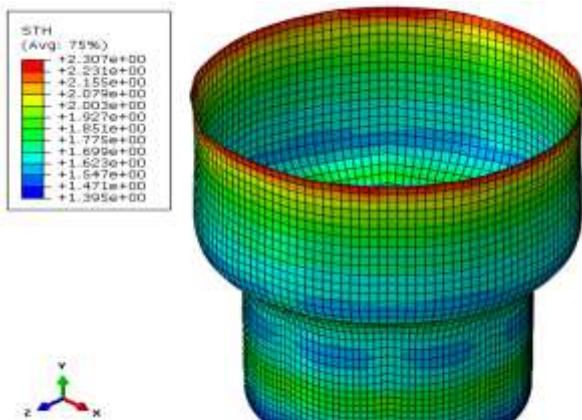

**Fig. 11** Final product after completing the four-step process.

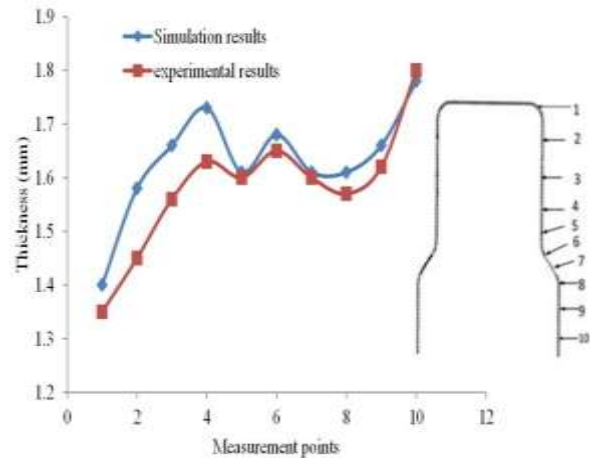

**Fig. 12** The corresponding four-step process on the actual sheet.

In accordance with the appropriate blank holder force to eliminate wrinkling and reduce the thinning, which was

determined through the numerical analysis, a series of experiment was conducted. The used initial blanks to perform the progressive four-step deep drawing process are shown in “Fig. 12”.

As it is obvious, by using the previously specified optimum blank holder forces no rupture was observed in the sheet and the desired shape was obtained. Furthermore, a comparison between the simulation and experimental results are performed (“Fig. 13”) in order to verify the accuracy of the numerical results of the final product thickness distribution.



**Fig. 13** Comparison between numerical and experimental results.

The comparison shows an appropriate accordance between the results. If the force is less than the optimum value in the fourth step, the wrinkling will not disappear. This defect, i.e. in the wall of the product, is illustrated in “Fig. 14”, both in the simulation and the experimental case.

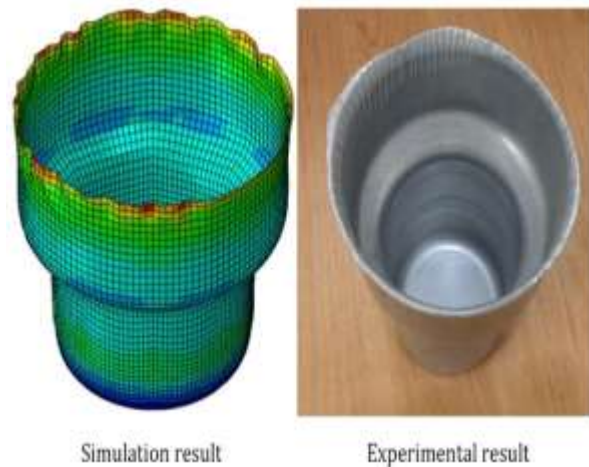

**Fig. 14** The sheet wall wrinkling as a result of low amount of blank holder force.

---

#### 4 CONCLUSIONS

---

In this study, the four-step deep drawing process of high strength aluminum sheet (AA7075-0) and the effect of blank holder force on the wrinkling and tearing defects were investigated. Thus, the numerical simulation of the process was carried out using ABAQUS/CAE software. According to the results, the optimum blank holder force is reduced to prevent wrinkling and tearing during the forming steps, so the optimum force is 28000 N and 600 N in the first and the fourth step, respectively. The blank holder forces obtained from the simulation were then used in the experimentations, and the desired final shape was achieved. It was observed that in the second, third and fourth steps, the wrinkling height is lower than in the first step. Also, due to the annealing of the sample between the forming steps, and the continuous reduction of the blank holder force in the progressive steps, the thinning amount decreases.

---

#### REFERENCES

---

- [1] Koc, M., Altan, T., An Overall Review of the Tube Hydroforming (THF) Technology, *Journal of Materials Processing Technology*, Vol. 108, No. 3, 2001, pp. 384-393.
- [2] Colgan, M., Monaghan, J., Deep Drawing Process: Analysis and Experiment, *Journal of Materials Processing Technology*, Vol 132, No. 1-3, 2003, pp. 35-41.
- [3] Vollertsen, F., Prange, T., and Sander, M., Hydroforming: Needs, Developments and Perspectives, *Advanced Technology of Plasticity*, Vol. 2, No. 1, 1999, pp. 1197-1209.
- [4] Hashemi, S. J., Naeini, H. M., Liaghat, G., Karami, J. S., and Roohi, A. H., Prediction of Bursting in Warm Tube Hydroforming using Modified Ductile Fracture Criteria, *Modares Mechanical Engineering*, Vol. 14, No. 16, 2015, pp. 201-211.
- [5] Choi, T., Choi, S., Na, K., and Bae, H., Chung W, Application of Intelligent Design Support System for Multi-Step Deep Drawing Process, *Journal of Materials Processing Technology*, Vol. 130, No. 1, 2002, pp. 76-88.
- [6] Sheng, Z., Taylor, R., and Strazzanti, M., FEM-Based Progressive Drawing Process Design, *The International Journal of Advanced Manufacturing Technology*, Vol. 36, No. 3-4, 2008, pp. 226-36.
- [7] Li, W., Meng, B., Wang, C., Wan, M., and Xu, L., Effect of Pre-Forming and Pressure Path On Deformation Behavior in Multi-Pass Hydrodynamic Deep Drawing Process, *International Journal of Mechanical Sciences*, Vol. 121, No. 1, 2017, pp. 171-180.
- [8] Sivasankaran, S., Narayanasamy, R., Jeyapaul, R., and Loganathan, C., Modelling of Wrinkling in Deep Drawing of Different Grades of Annealed Commercially Pure Aluminium Sheets When Drawn Through a Conical Die Using Artificial Neural Network, *Materials & Design*, Vol. 30, No. 8, 2009, pp. 3193-3205.
- [9] Tikhovskiy, I., Raabe, D., and Roters, F., Simulation of Earing During Deep Drawing of an Al-3% Mg Alloy (AA 5754) Using a Texture Component Crystal Plasticity FEM, *Journal of Materials Processing Technology*, Vol. 183, No. 2-3, 2007, pp. 169-175.
- [10] Liu, W., Chen, B. K., Sheet Metal Anisotropy and Optimal Non-Round Blank Design in High-Speed Multi-Step Forming of AA3104-H19 Aluminium Alloy Can Body, *The International Journal of Advanced Manufacturing Technology*, Vol. 95, No. 9-12, 2018, pp. 4265-4277.
- [11] Qayyum, F., Shah, M., Muqet, A., and Afzal, J., The Effect of Anisotropy On the Intermediate and Final Form in Deep Drawing of Ss304L, With High Draw Ratios: Experimentation and Numerical Simulation, *IOP Conference Series: Materials Science and Engineering*, Vol. 146, No. 1, 2016, pp. 012031
- [12] Proubet, J., Baudelet, B., Rupture Criteria During Deep Drawing of Aluminum Alloys, *Studies in Applied Mechanics*, Vol. 45, No. 1, 1997, pp. 289-297.
- [13] Zhang, W., Tor, S., and Britton, G., Indexing and Retrieval in Case-Based Process Planning for Multi-Stage Non-Axisymmetric Deep Drawing, *The International Journal of Advanced Manufacturing Technology*, Vol. 28, No. 1-2, 2006, pp. 12-22.
- [14] Abdelmaguid, T. F., Abdel-Magied, R. K., Shazly, M., and Wifi, A. S., A Dynamic Programming Approach for Minimizing the Number of Drawing Stages and Heat Treatments in Cylindrical Shell Multistage Deep Drawing, *Computers & Industrial Engineering*, Vol. 66, No. 3, 2013, pp. 525-532.
- [15] Pacheco, M., Celentano, D., García-Herrera, C., Méndez, J., and Flores, F., Numerical Simulation and Experimental Validation of a Multi-Step Deep Drawing Process, *International Journal of Material Forming*, Vol. 10, No. 1, 2017, pp. 15-27.
- [16] Brown, W. F., Mindlin, H., and Ho, C. Y., *Aerospace Structural Metals Handbook: CINDAS/USAF CRDA Handbooks Operation*, Purdue University, West Lafayette, USA, Code 3206, Vol. 3, 1996.
- [17] Sheng, Z., Jirathearanat, S., and Altan, T., Adaptive FEM Simulation for Prediction of Variable Blank Holder Force in Conical Cup Drawing, *International Journal of Machine Tools and Manufacture*, Vol. 44, No. 5, 2004, pp. 487-494.